



CANADA

BOOTHS & LARGE FORMAT DISPLAYS FOR VISUAL COMMUNICATION

2017



BERLINdisplays.com | info@berlindisplays.com
514.939.3600

RETAIL PRICING

The prices provided in this catalogs are suggested retail prices excluding taxes in Canadian dollars.

The rental prices do not include shipping nor set-up or dismantling.

As we are constantly improving and adding to our product line, we reserve the right to change product specifications and prices without notice.

Although this document has been produced with the utmost of care, it may contain errors or omissions that are not binding for the distributor of this catalogs. Only the final quote is binding.

We also invite you to review the catalogue distributor's General Terms and Conditions of sale.

The trademarks and logos found in this catalogs are the property of their respective owners and are used only as presentation suggestions.

intro

3

our mission / our services / our expertise

transportable solutions

panoramic®
full visual system

9

panoramic presentation / modular panoramic h-line booths / creative panoramic c-line booths / portable panoramic p-line booths / panoramic booth complements

portable solutions

47

fabric booths / fabric pop-ups / fabric pop-up counter

ultra-portable solutions

63

retractables and banner stands

outdoor solutions

69

flags

fabric frames

73

wall frames & lightboxes

accessories & packaging

79

accessories & transport solutions

tips & tricks

84

graphic creation / exhibit advice

summary

We provide turnkey solutions for peace of mind, responsiveness and quality

- Booth design: your personalized solution in 5 days



Our design office is able to create and quote the booth that corresponds to your needs within 5 days thanks to our 3D configurator.

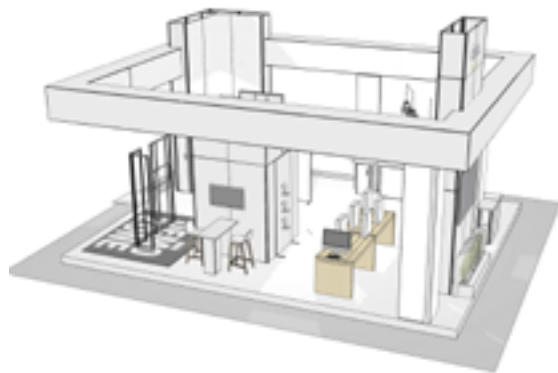

- This manufacturing process takes place entirely at our production facility in Canada



The production line is fully integrated (aluminum profiles, fabric graphics, wood working) to guarantee total reliability and responsiveness.



- Quality control: 100% of booths are inspected by our experts



Each booth that is manufactured in our facilities undergoes a trial assembly to guarantee perfect quality.



We offer a wide range of complementary services*

- Optimized logistics services to ensure that you receive the best service possible

Our logistics service offers optimized solutions tailored to your needs to ensure that you get the best prices and responsiveness.



- Booth rental: smart, economical solutions for occasional needs

Are you only exhibiting once and do not know if you have another event within the year?

Opt to rent a booth and save money.



**contact us for the pricing details of these services*

- Setup and disassembly: a worldwide network at your fingertips

Our network allows us to provide you with support all over the world by providing quality services at the right price while ensuring that you remain in close contact with your local sales representative. A guarantee of success for your exhibit!



- Storage services to store your graphics

If you so desire, we can offer you storage services to store your graphics so that you may reuse them at a future time.



Our purpose: create, design and build exhibition booths that meet your needs

- Are you looking for unique, high-impact exhibit solutions?

All of our solutions are created to put the spotlight on your image. The structures, textiles and printing techniques have been developed jointly. The results: high quality and exceptional impact that helps showcase your image.

The endless combinations possible between panels and accessories ensure that your booth is unique.



- Are you an agile company looking for solutions tailored to your own pace?

A company exhibits 5 times a year* on average. This is why we design changeable, modular and reconfigurable booths with endless possibilities. A range of accessories are optional to make them even more functional.

**Source : French study by Unimev « Salons et Foires: un puissant outil de développement pour les entreprises »*



Viscom Paris

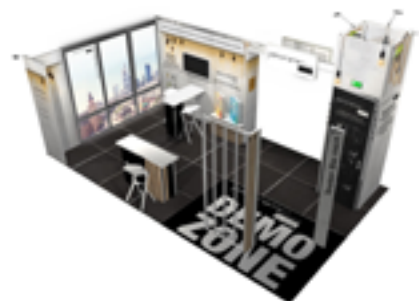

Viscom Frankfurt



EDPA Orlando

- Is limiting your environmental impact important to you?

All throughout the life cycle of our products, we implement concrete actions with our network to minimize environmental impact. The design process favors recycled or recyclable materials. All products are repairable in order to increase their lifespan. Production is carried out mainly in Canada and Europe. We generate three times more electricity than what we consume thanks to the 788 solar panels installed on the roof of our factory in Europe. We are working on making all of our booths reusable and sharable in order to design the eco-friendly display of the future.



Our aluminum and graphics are systematically recycled.

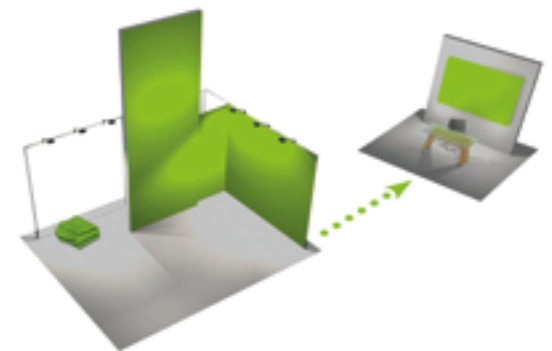
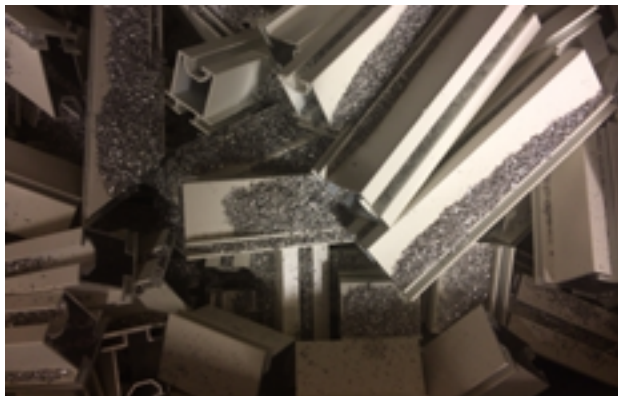

Our expertise in dye-sublimation printing on fabric to benefit your communication

- Why choose fabric graphics?

Fabric graphics are very well suited for use in the exhibit and events industries. They are easy to transport, handle and set up; they are scratch-resistant, wrinkle-free and washable, and may even be dry-cleaned.

They offer unrivaled aesthetic rendering with the best color execution that won't fade over time.



- What is dye-sublimation printing?

Sublimation is a physical phenomenon by which matter passes directly from a solid to a gas. The fabric's fibers are dyed directly, which improves color resistance over time.

- Benefits of this technology

- Unrivaled quality: dye-sub printing offers exceptional contrast, intensity and depth. Colors are vibrant and available in a wide range, including at high density.
- Anti-reflective: dye-sublimated fabric absorbs light and prevents reflections from appearing on your image.
- More eco-friendly process: the inks used are aqueous solutions that are solvent-free and odorless.





panoramic®
full visual system

- Portable, custom or modular exhibit solutions
- Standard and custom configurations for all booth sizes
- Packaged in wheeled transport bags or crates
- May be set up with or without professional assistance

transportable solutions

panoramic®
full visual system

A booth solution that
complements your image!

panoramic is the only modular
booth solution* that allows you to
cover the entire frame with your
image.

With a space that is entirely
dedicated to your image and
dye-sublimation fabric, it creates
unparalleled graphic impact and
a top-of-the-line finish.

The textile-sublimation
combination is not only more
qualitative and offers a better
color rendering, but is also more
respectful of the environment.

panoramic is thus the most
creative and effective solution to
highlight your message.

**Patented system*



Choose the best solution for your needs!

panoramic®
h-line

Modular solution, endlessly reconfigurable,
available for purchase or rental.

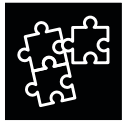

modular



rental

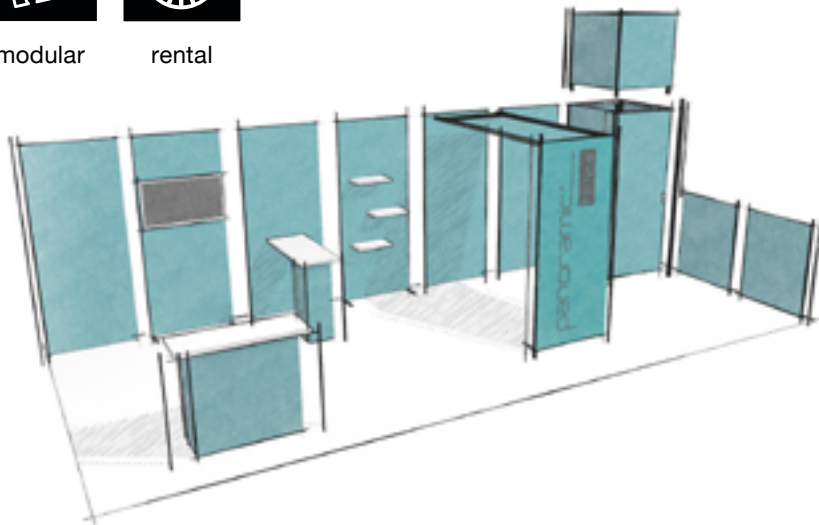

panoramic®
c-line

Creative solution, ideal for custom booths.



design



custom

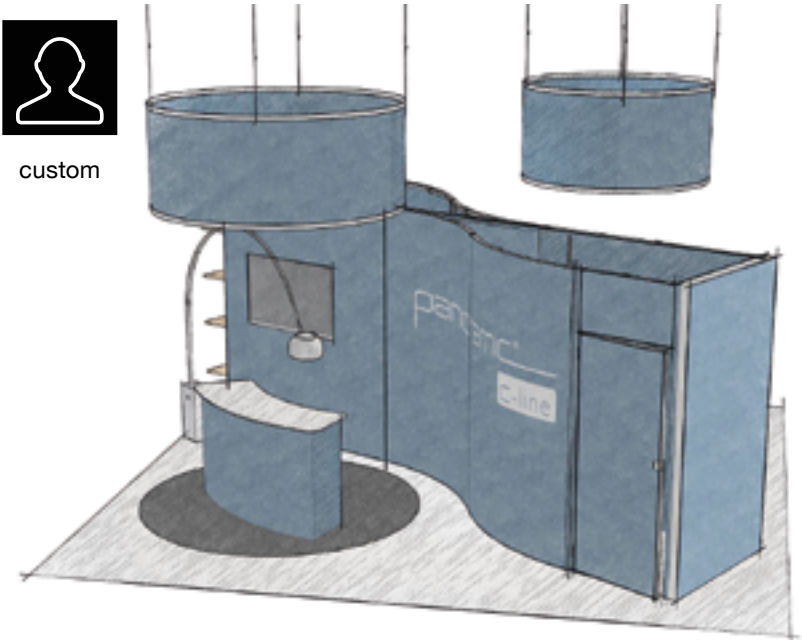

Also available in a portable solution with panoramic p-line, ideal for 10' and 20' booths. Profiles are cut in two (length: 53" max) and transported in wheeled bags.

panoramic®
P-line



modular

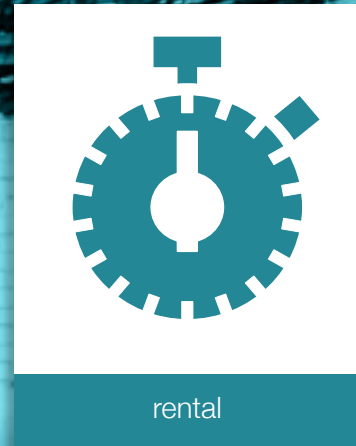

rental

- Modular booths, ideal for 10'x10', 10'x20', 10'x30' and 20'x20' spaces
- Packaged in a wheeled crate, with frames and graphics pre-assembled
- May be set up with or without professional assistance

panoramic[®]
h-line

Modular booths

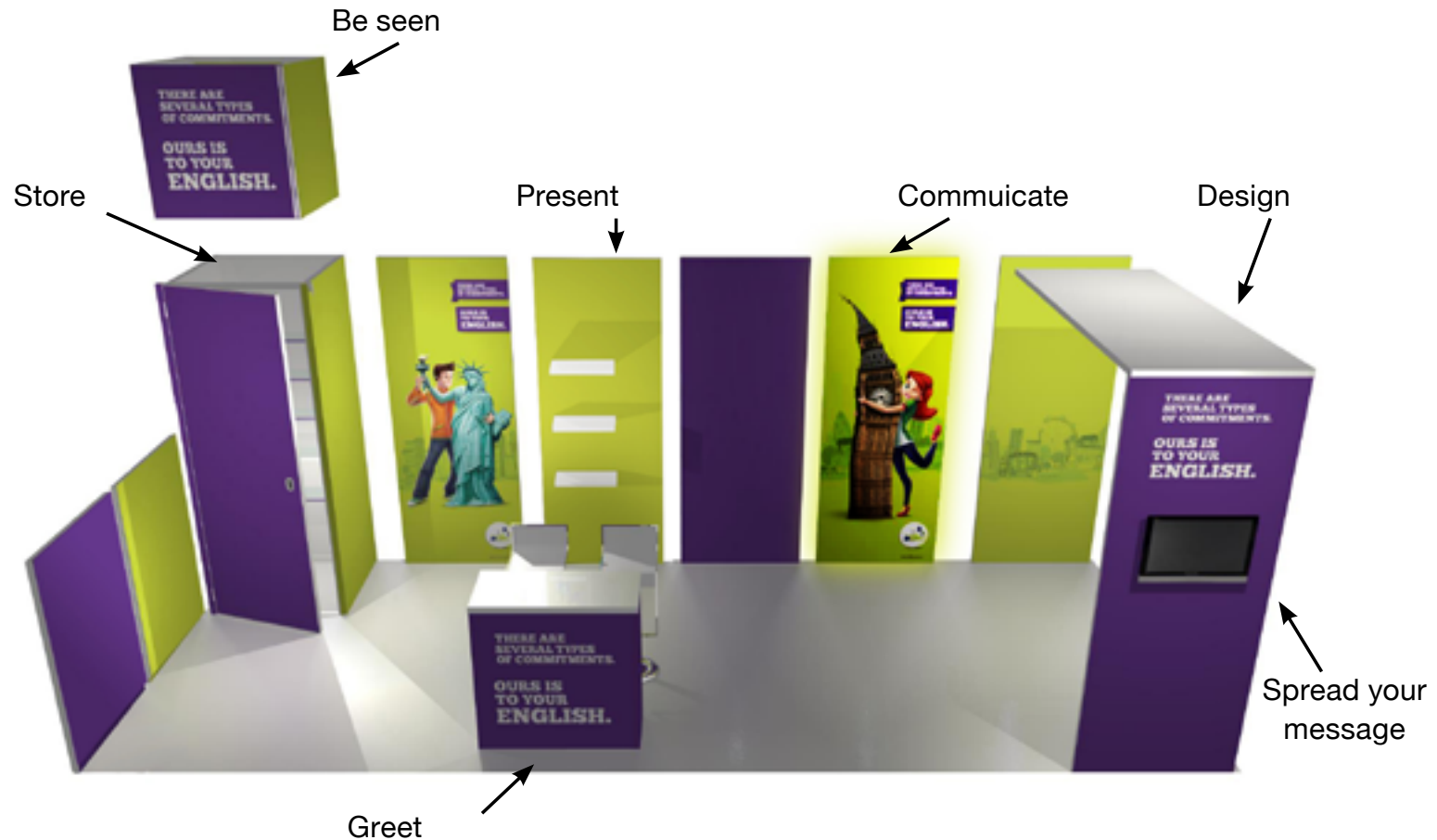
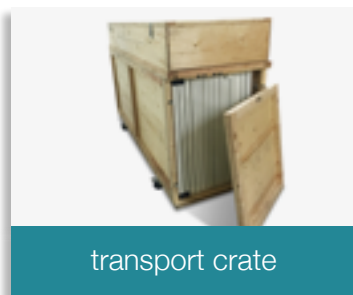
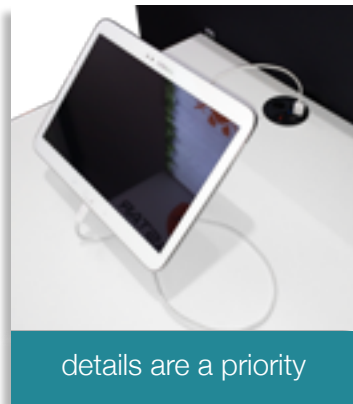

- Create a customized booth using pre-assembled modules that offer a wide range of functionalities
- The visual impact of h-line is created through large format, high-definition fabric graphics. The connections between the panels are invisible
- A 10' x 20' booth can be set up in less than an hour

100% modular: 13 modules, 4 shows, 4 configurations, 4 locations

Reconfigure your h-line booth to suit your event, using the same pack of modules each time

10'x10'

Montréal



10'x10'

Chicago



10'x20'

Toronto



10'x20'

Las Vegas



100% modular: 13 modules for an unlimited number of configurations!

13 module pack

- 1 HMS038 standard module
- 1 HMS038-L standard lightbox module
- 2 HMS019 standard modules
- 2 HMS138 standard half-height modules
- 1 HMF038-01 brochure-holder module
- 1 HMC338B console module
- 1 HMT012 shelving module
- 1 HMC119 counter module
- 1 HMR119 counter module
- 1 HMH047-L signage module
- 1 HMV538-L lightbox arch module
- 1 SOS kit
- 2 LED lights
- 1 H3 crate

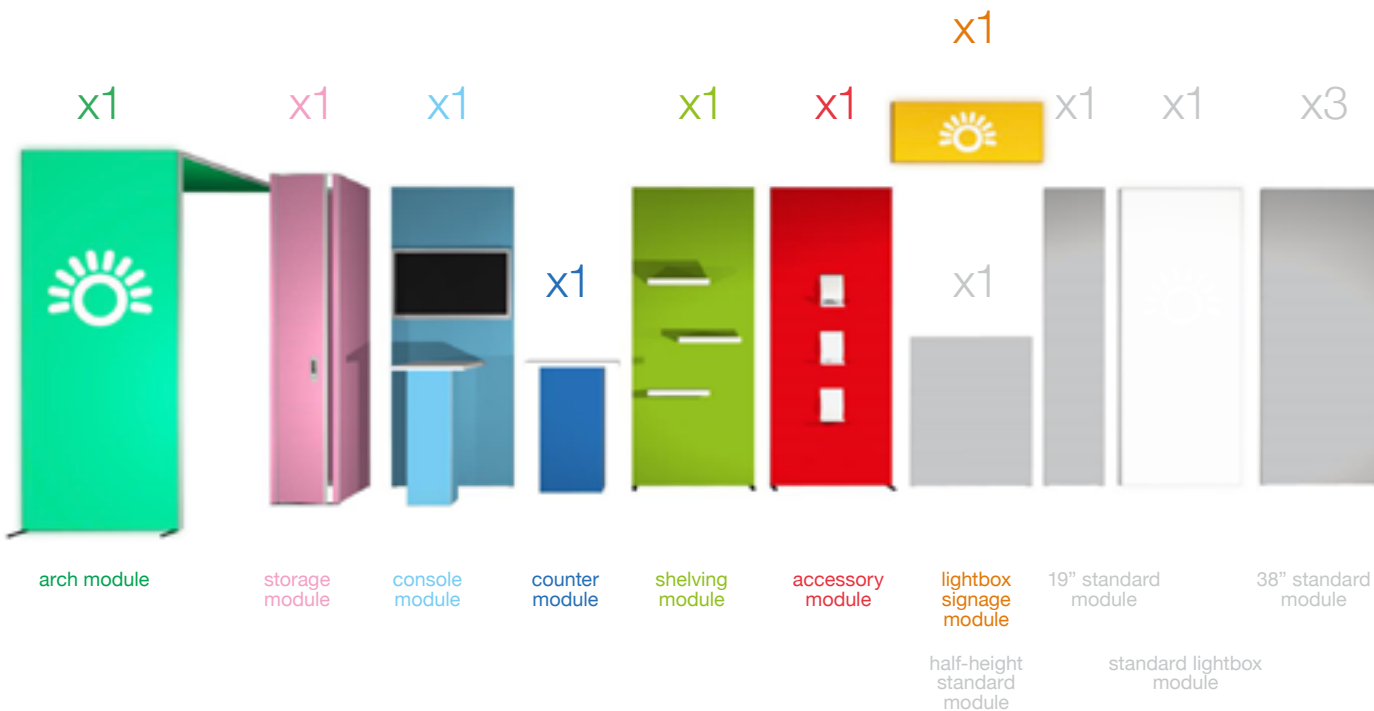

Purchase* \$ **20,712**

Rental* \$ **10,189**

*TV not included in price.

Rental price includes custom-printed graphics.



h10-03

Structure + counter + graphics
+ 2 LED lights + packaging

Purchase* \$ **8,457**

Rental* \$ **4,473**

*furniture and printed carpet not included

Option (unit price)

	Purchase
printed carpet	
panofloor	\$ 1,500



HMC119 counter



LED light

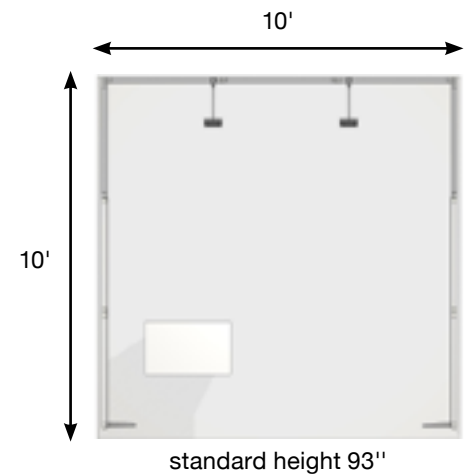

**Rental price includes custom-printed graphics*



h20-12

Structure + counter + graphics
+ packaging

Purchase* \$ **12,710**

Rental* \$ **6,984**

*furniture and printed carpet not included

Option (unit price)

	Purchase
printed carpet	
panofloor	\$ 3,000



HMC038 counter

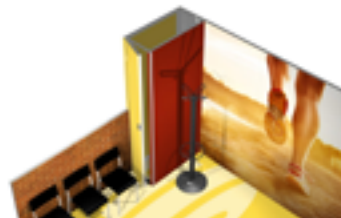

HMR119 closet module



standard height 93"

**Rental price includes custom-printed graphics*



h10-04

Structure + counter + graphics
+ 2 LED lights + packaging

Purchase* \$ **9,740**

Rental* \$ **4,858**

*furniture and printed carpet not included

Option (unit price)

	Purchase
printed carpet	
panofloor	\$ 1,500



shelving module (HMT014)



HMC019 counter

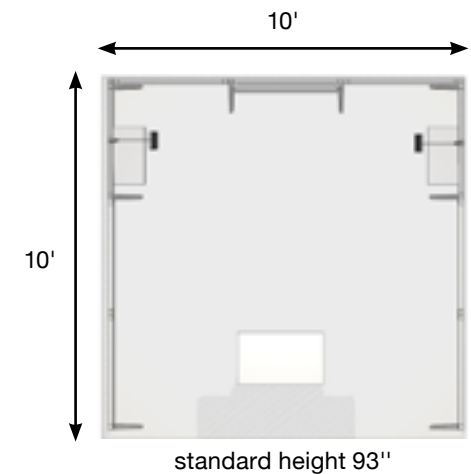

**Rental price includes custom-printed graphics*



h2o-08

Structure + graphics
+ packaging

Purchase* **\$ 18,813**

Rental* **\$ 8,542**

*furniture and printed carpet not included

Option (unit price)

	Purchase
printed carpet	
panofloor	\$ 3,000



console modules with USB hub and
tablet holder



HMT038 accessory module

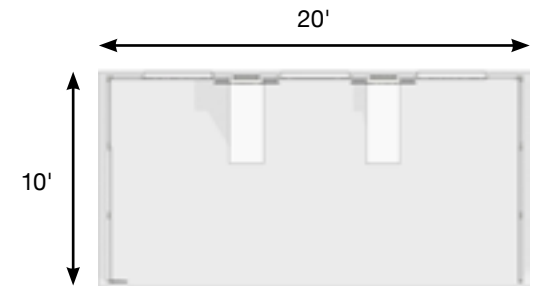

standard height 93"

**Rental price includes custom-printed graphics*



Brochure holders

h20-23

Structure + counter + graphics
+ 4 LED lights + packaging

Purchase* \$ **14,477**

Rental* \$ **7,028**

*furniture and printed carpet not included

Option (unit price)

	Purchase
printed carpet	
panofloor	\$ 3,000



HMV019A arch module



2 brochure holders module
HMF038-02

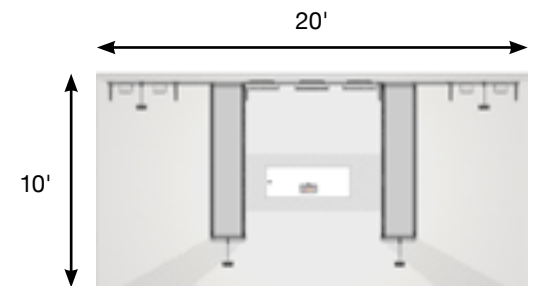
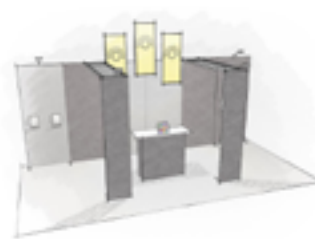

standard height 93"

**Rental price includes custom-printed graphics*



h20-24

Structure + counters + graphics
+ 3 LED lights + packaging

Purchase* \$ **26,748**

Rental* \$ **12,827**

*furniture and printed carpet not included

Option (unit price)

	Purchase
printed carpet	
panofloor	\$ 3,000



brochure holders and TV



HMC038-USB counters with
HMC003 module and tablet holders

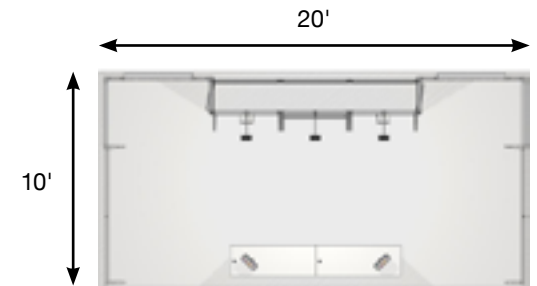

standard height 131"

**Rental price includes custom-printed graphics*

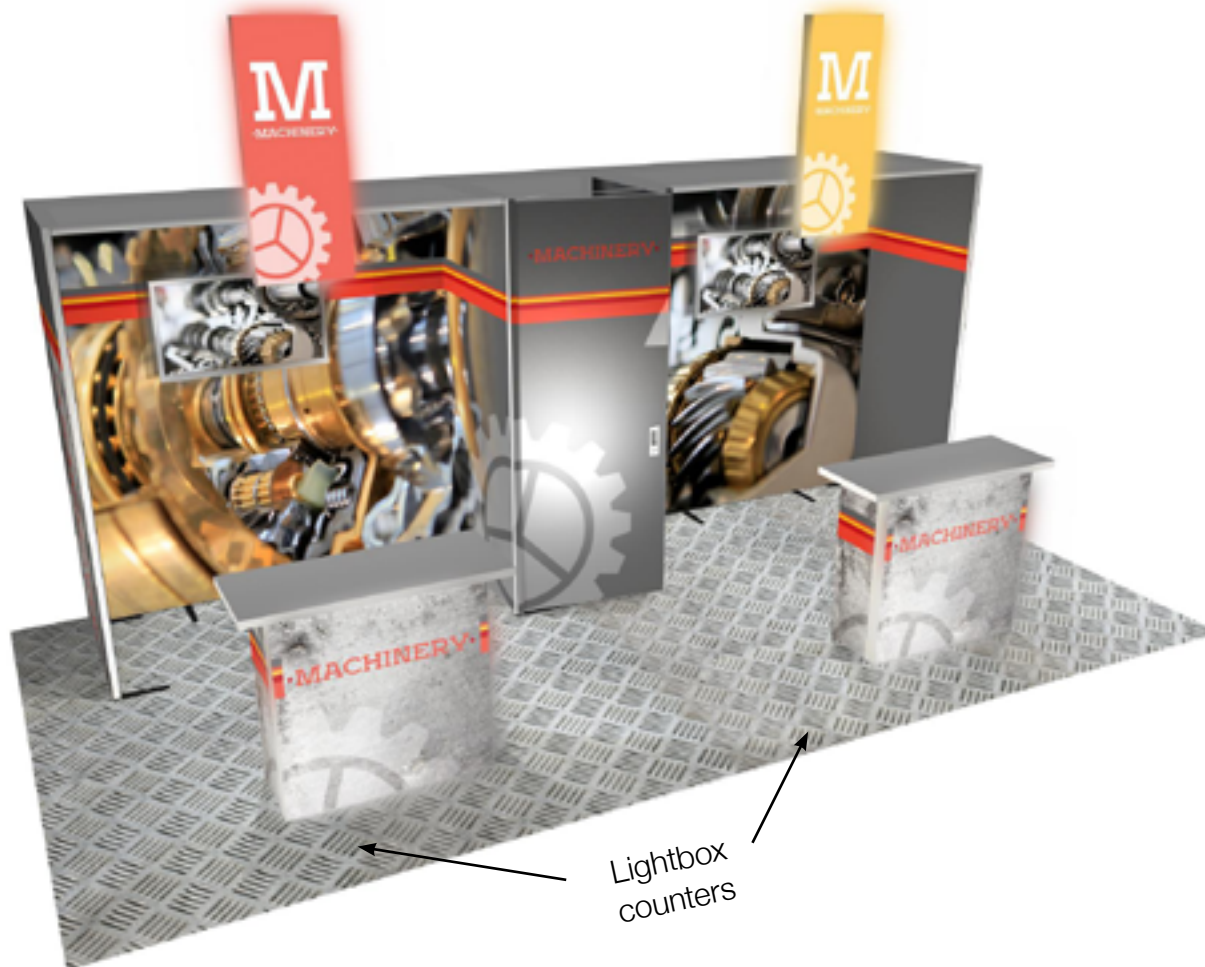

Lightbox
counters

h20-25

Structure + counters
+ graphics + packaging

Purchase* \$ **19,978**

Rental* \$ **10,211**

*furniture and printed carpet not included

Option (unit price)

	Purchase
printed carpet	
panofloor	\$ 3,000

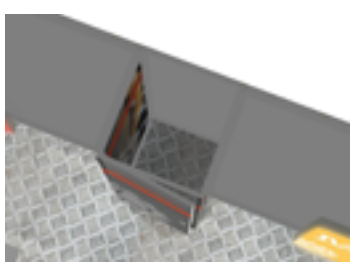

HMR038 storage module



HMH047-L signage modules

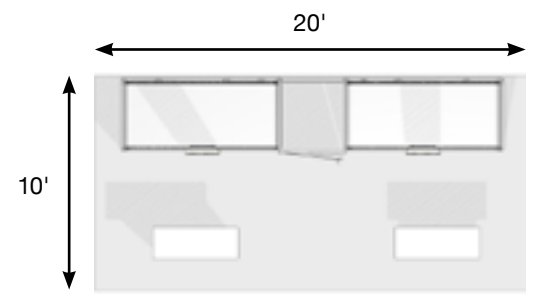
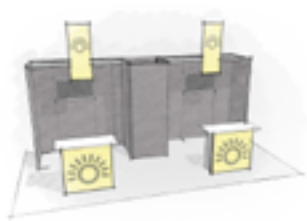

standard height 93"

**Rental price includes custom-printed graphics*

New!
Easily change
your message with the wallframe



h2o-26

Structure + counter + graphics
+ 4 LED lights + packaging

Purchase* \$ **18,546**

Rental* \$ **9,608**

*furniture and printed carpet not included

Option (unit price)

	Purchase
printed carpet	
panofloor	\$ 3,000



HMR119 closet module



HMF138 wallframe module

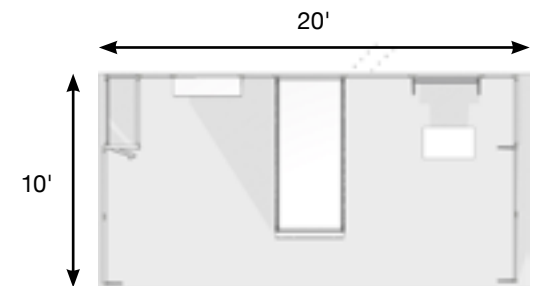

standard height 93"

**Rental price includes custom-printed graphics*



New!
Complete your booth with
brochure holders

h20-27

Structure + counter + graphics
+ 4 LED lights + packaging

Purchase* \$ **16,490**

Rental* \$ **8,597**

*furniture and printed carpet not included

Option (unit price)

	Purchase
printed carpet	
panofloor	\$ 3,000



HMV138B TV module with arch

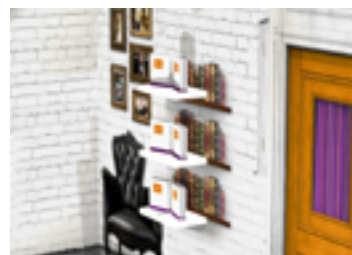

HMT013 shelf module

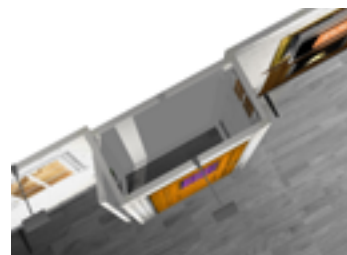

HMR119 closet module

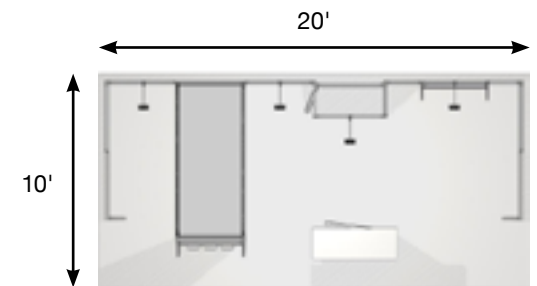

standard height 93"

**Rental price includes custom-printed graphics*

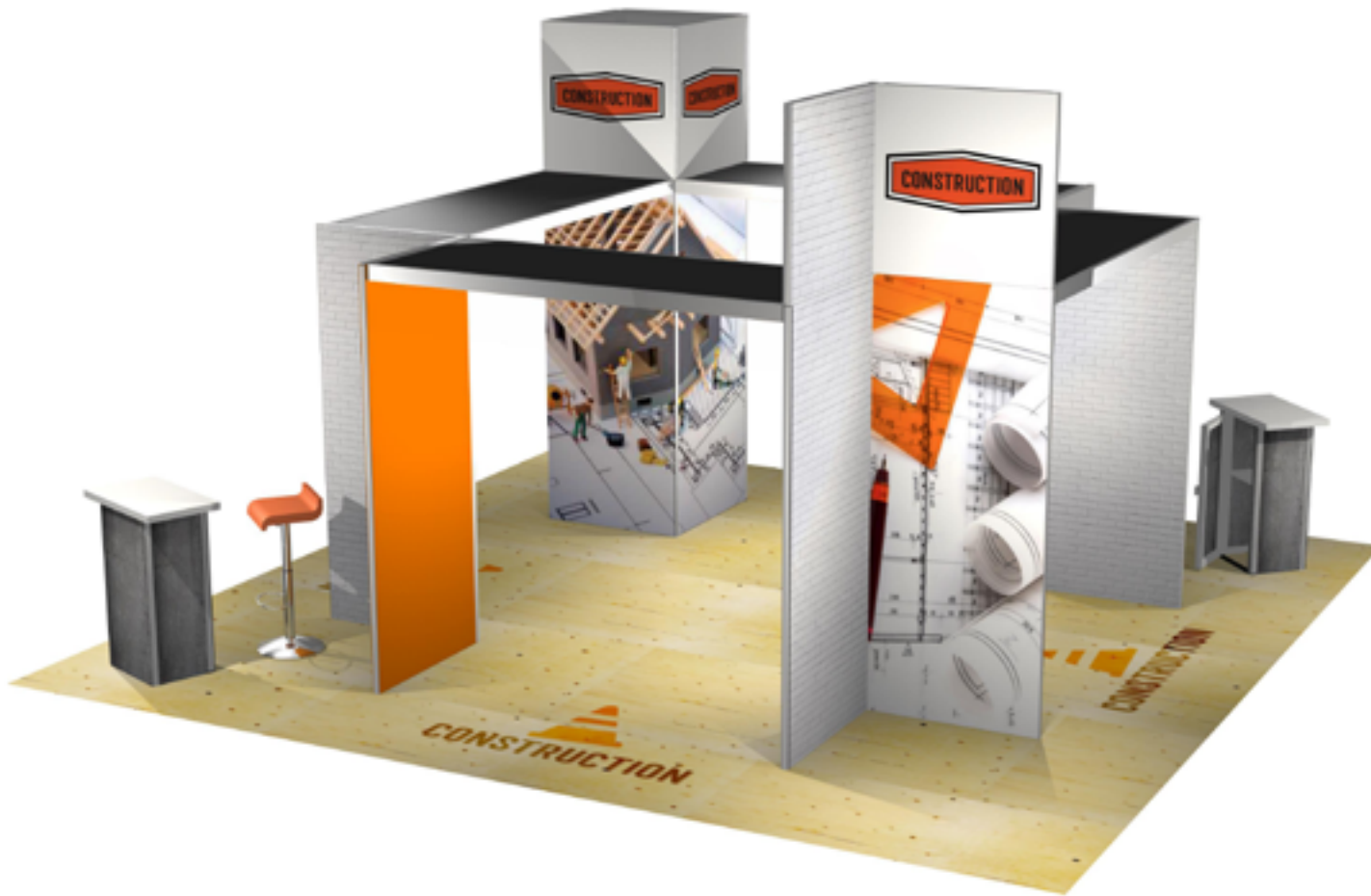

h2o-10

Structure + counters
+ graphics + packaging

Purchase* \$ **27,925**

Rental* \$ **14,831**

*furniture and printed carpet not included

Option (unit price)

	Purchase
printed carpet	
panofloor	\$ 6,000



HMV438-L arch module with canopy lightbox

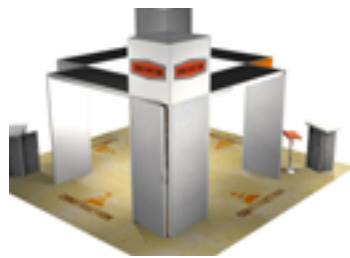

HMR038 storage module

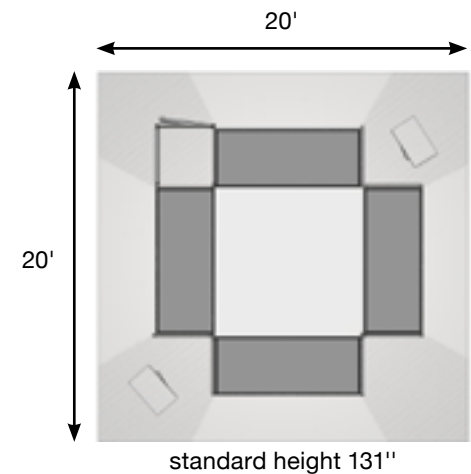

**Rental price includes custom-printed graphics*

A function for every module

Standard modules

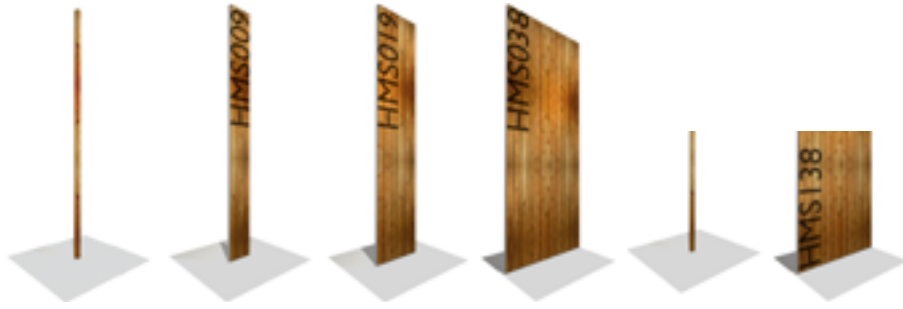

Standard lightbox modules



Door module



Shelving modules



Multimedia modules



Accessory modules

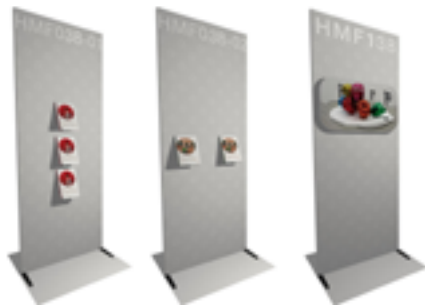

Arch modules

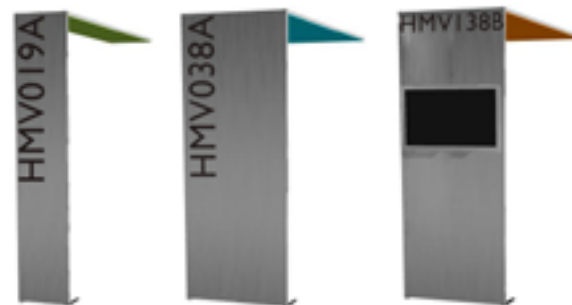

Lightbox arch modules



Storage modules

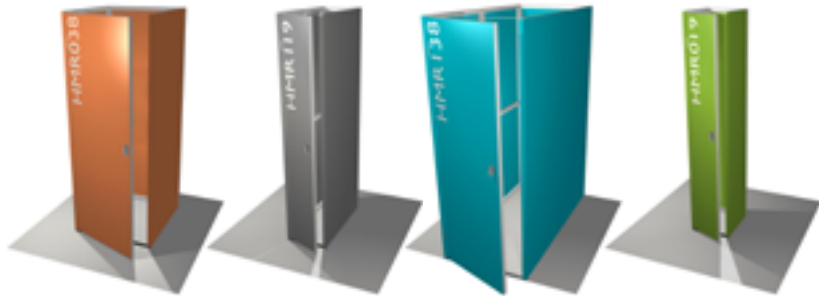

Header modules

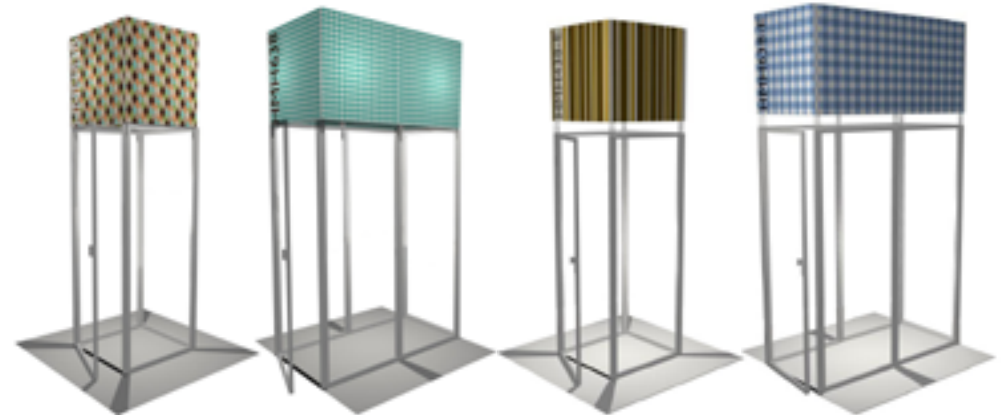

Signage modules

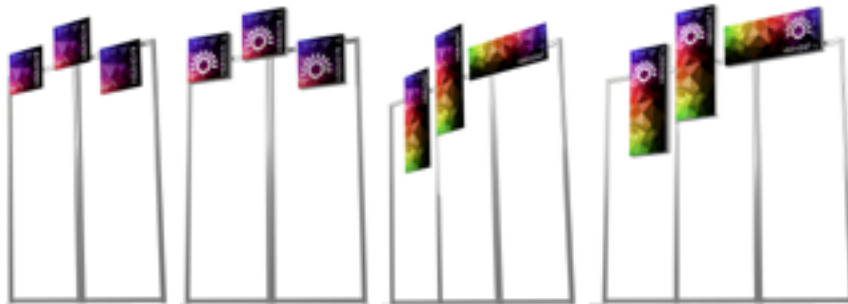

Console modules*



Lightbox counter modules*



Counter modules*

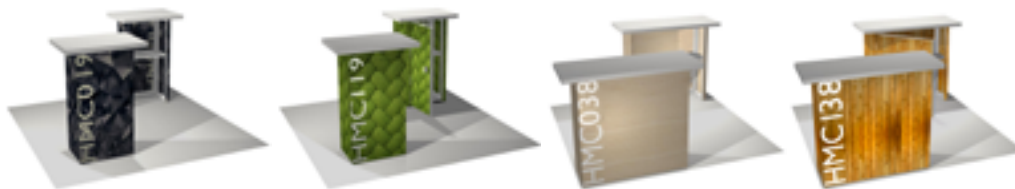

Connection modules



*with USB hub option

See more configurations in the booth library:
<http://panoramic-display.com/us/library.html>



Design by l'air de rien Paris / www.designlairderien.com



design



custom

- Custom booths, no compromise on design
- Reusable
- To be set up by professionals

panoramic[®]
c-line

Custom and creative booths



lightbox



LED integrated into the profile



curved elements



custom woodwork



- Make a big impact with booths tailored to your image
- Bring your ideas to life with panoramic: large-format graphics, backlit walls, curved elements, woodwork element integration, heights up to 16'
- panoramic booths are reusable!
- panoramic lightboxes are UL certified





C20-25

Structure + graphics + 9 LED lights + packaging

Purchase* **\$ 13,036**

*excludes furniture and counters

Transport solution
1 medium wood crate

Options (unit price)

	Purchase
counter	
PC02	\$ 946
printed carpet	
panofloor	\$ 6,000



non-hanging header



3 greeting areas

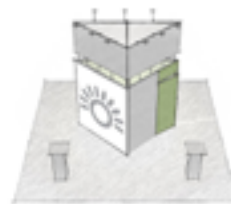

1 backlit side

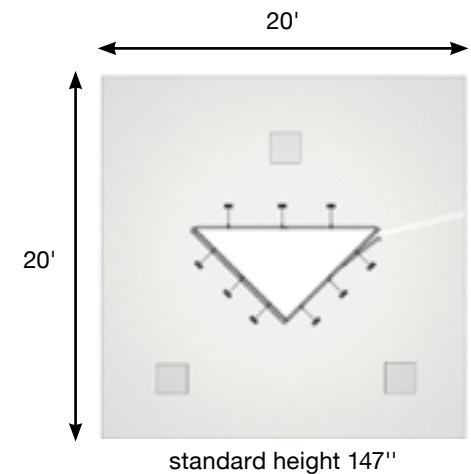



C20-26

Structure + graphics + counter
+ 8 LED lights + double-sided
L-shaped lightbox wall + 4
doublesided lightbox totems
+ packaging

Purchase* **\$ 39,122**

*excludes furniture and multimedia

Transport solution
2 large wood crates

Option (unit price)

	Purchase
printed carpet	
panofloor	\$ 6,000



100% backlit corner



lightbox totems

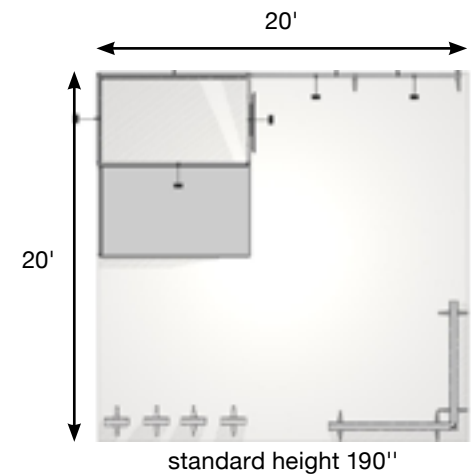

*for 22" to 50" screens, 44 lbs max, not included



C30-25

Structure + graphics + 2 double-sided L-shaped lightbox walls + counters + 6 LED lights + packaging

Purchase* **\$ 44,917**

*excludes furniture

Transport solution

1 large wood crate + 1 medium wood crate

Options (unit price)

	Purchase
brochure holder	
HOLD.UP CLASSIC	\$ 399
printed carpet	
panofloor	\$ 6,000



backlit corner



printed carpet
(option)

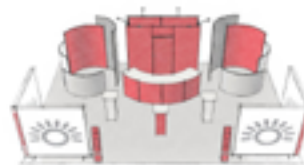

double-sided lightbox corners

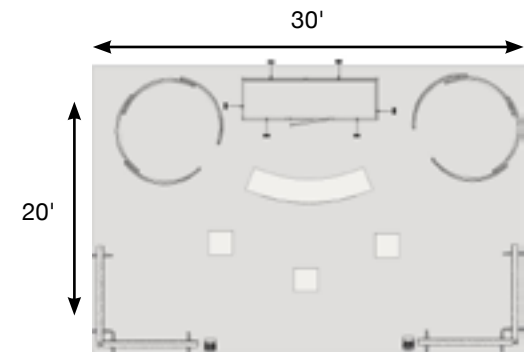

standard height 95"



C20-27

Structure + graphics + counter
+ 7 LED lights + packaging

Purchase* **\$ 20,208**

*excludes furniture & multimedia

Transport solution
1 large wood crate

Option (unit price)

	Purchase
printed carpet	
panofloor	\$ 6,000

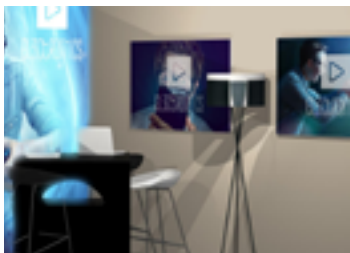

classic wall.frame

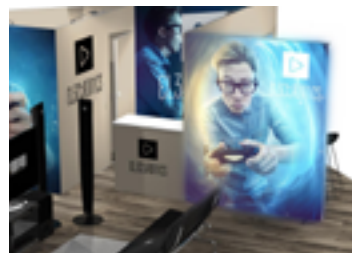

double-sided lightboxes

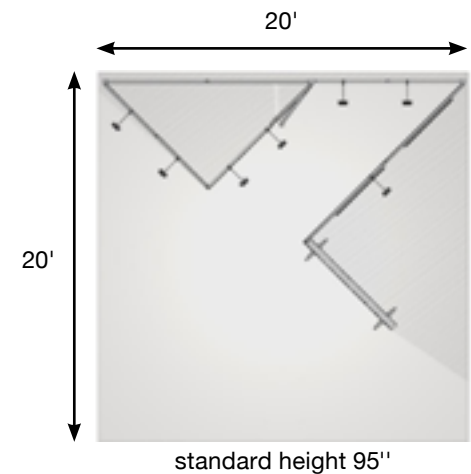

Couldn't find the perfect configuration?
Let us create it for you!



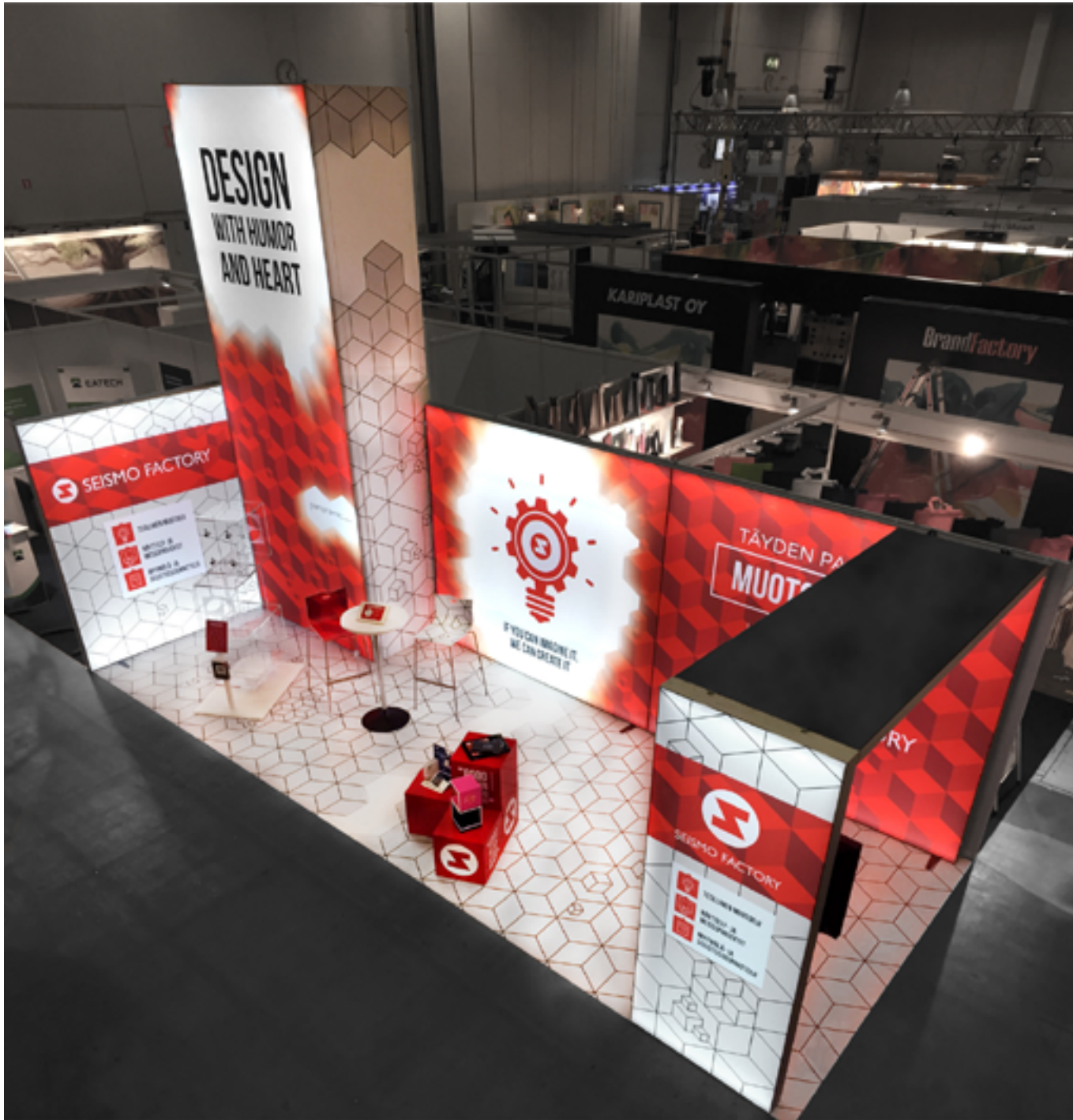

See more configurations in the booth library:

<http://panoramic-display.com/us/bibliotheque.html>





- Portable configurations ideal for 10'x10' and 10'x20' spaces
- Packaged in wheeled panoramic bags
- Can be assembled without assistance

Safely store and transport your booth



Max load: 66 lbs

wheeled.bag

TRB011

\$ **200**

Exterior dimensions:
16" x 16" x 35"

Weight:
22 lbs



soft profile.cover*

MER-SOFT-BAG

\$ **55**/unité

*maximum 2 profile covers per wheeled bag

panoramic®
P-line

Portable booths



10' x 10'

p10-05

Structure + graphics + 2 LED lights + packaging

Purchase* \$ **6,168**

*excludes furniture, multimedia & panofloor

Transport solution

3 wheeled panoramic bags



Also available in 20' version
p20-05

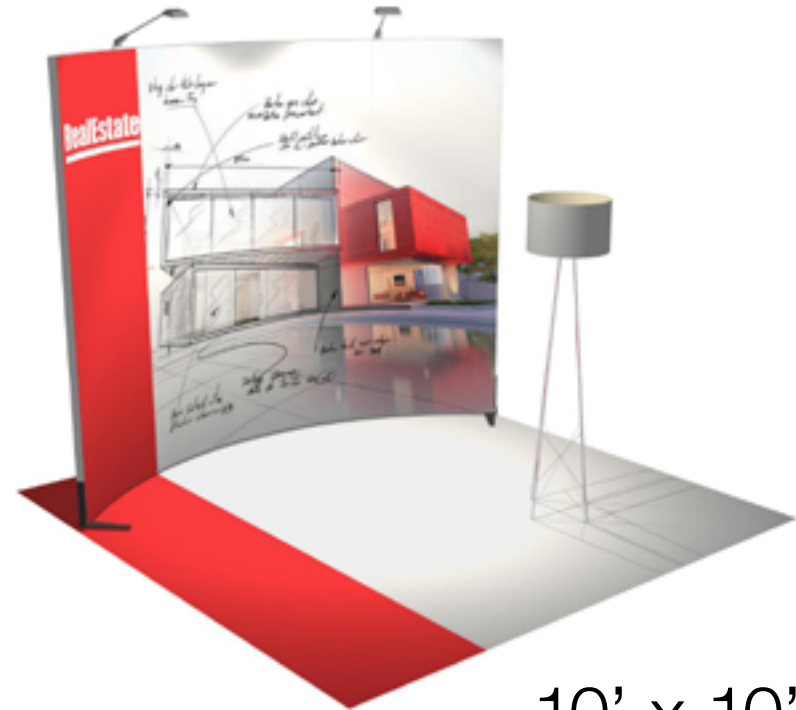

10' x 10'

p10-25

Structure + graphics + 2 LED lights + packaging

Purchase* \$ **4,396**

*excludes furniture & panofloor

Transport solution

2 wheeled panoramic bags



Also available in 20' version
p20-25



- These products are designed to complement your panoramic booth
- Printed carpets and hanging signs to create a fully immersive environment
- Counters and TV totems to add functionality
- Optimized transport solutions

panoramic complements

Panofloor, personalize your booth's floor!



examples

- Add personality to your booth by immersing visitors in your world
- Large-format dye-sublimation printed carpet, available up to 10ft wide without a seam
- Ideal for all your events: fairs, trade shows, conferences, seminars

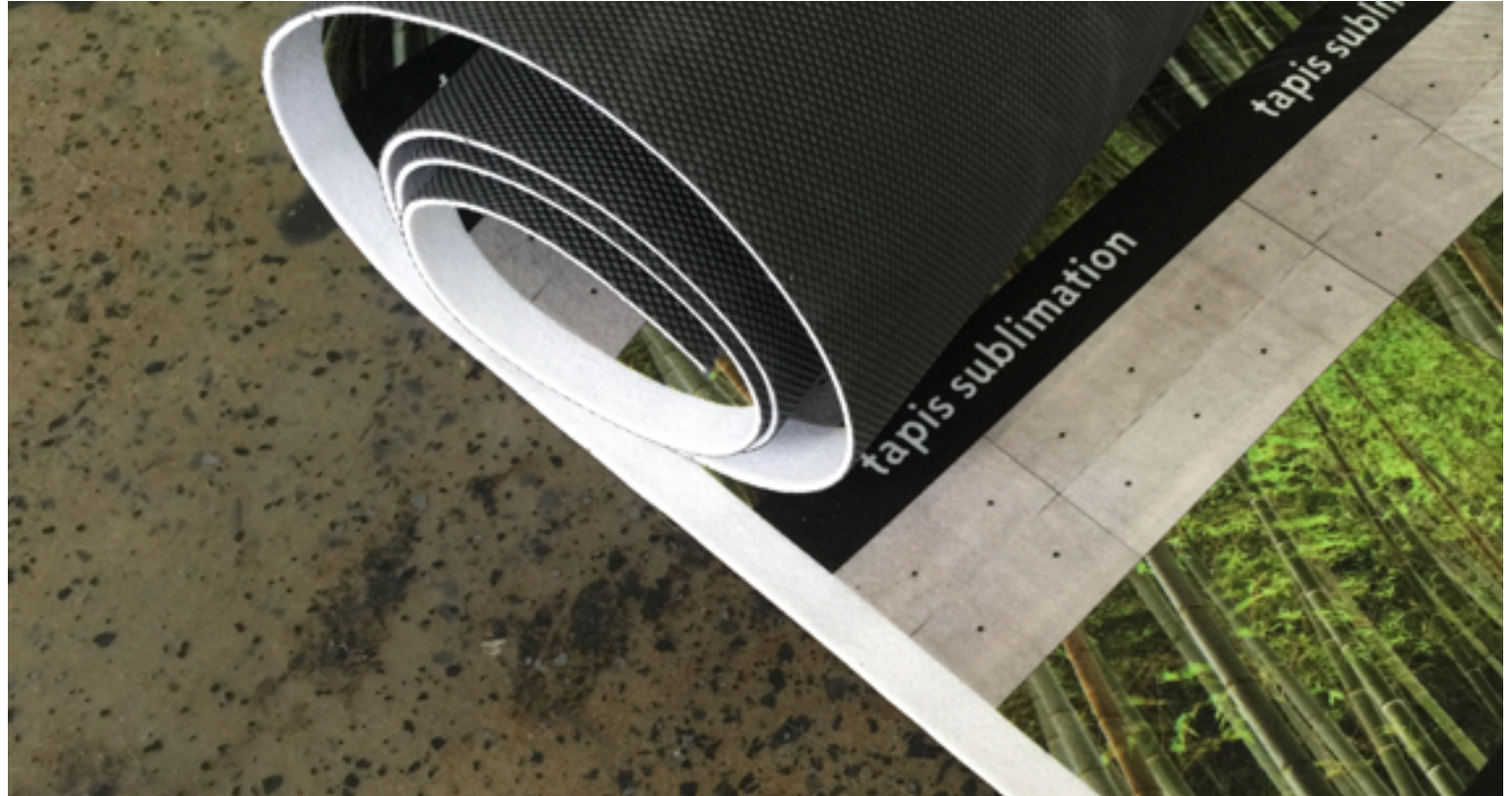

panofloor.

10' x 10'	\$ 1,500
10' x 20'	\$ 3,000
10' x 30'	\$ 4,500

Other dimensions \$ **15** /ft²

Counters, to greet visitors!

panoramic®
h-line

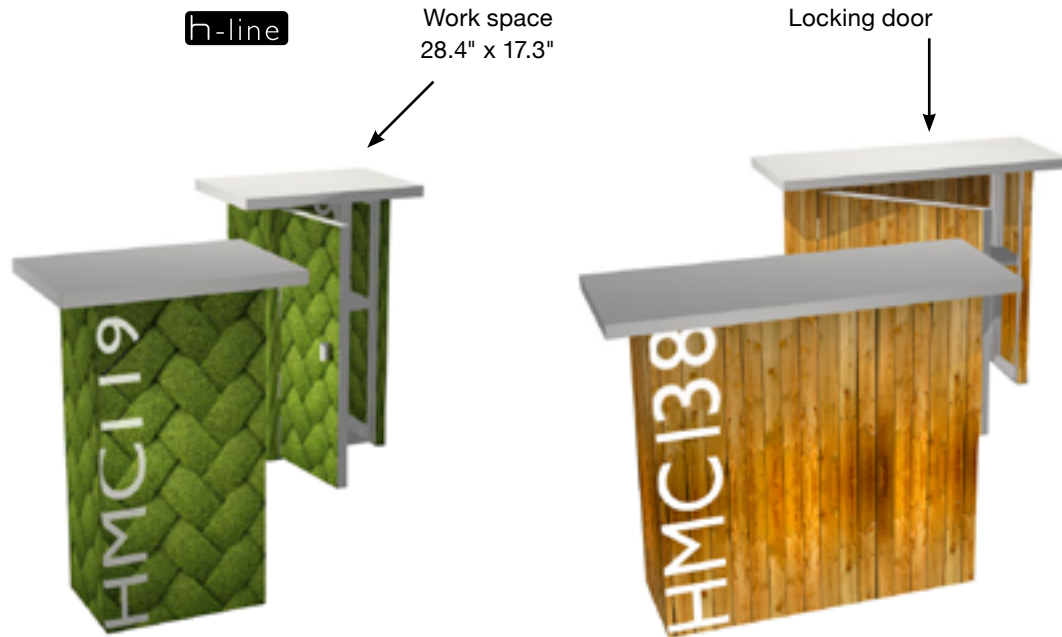

Work space
28.4" x 17.3"

Locking door

hmc119

Small counter module with door
(19" x 38" x 12") + dye-sub graphics

Purchase \$ **1,392**
Rental* \$ **599**

hmc119-usb

Option with USB hub

Purchase \$ **1,532**
Rental* \$ **640**

Counter height
39.4"

hmc138

Medium counter module (38" x
38" x 12") + dye-sub graphics

Purchase \$ **1,791**
Rental* \$ **824**

hmc138-usb

Option with USB hub

Purchase \$ **1,931**
Rental* \$ **866**

Counter height
39.4"

Work space
47.4 x 19.3"

Backlit counter
panoramic®
h-line

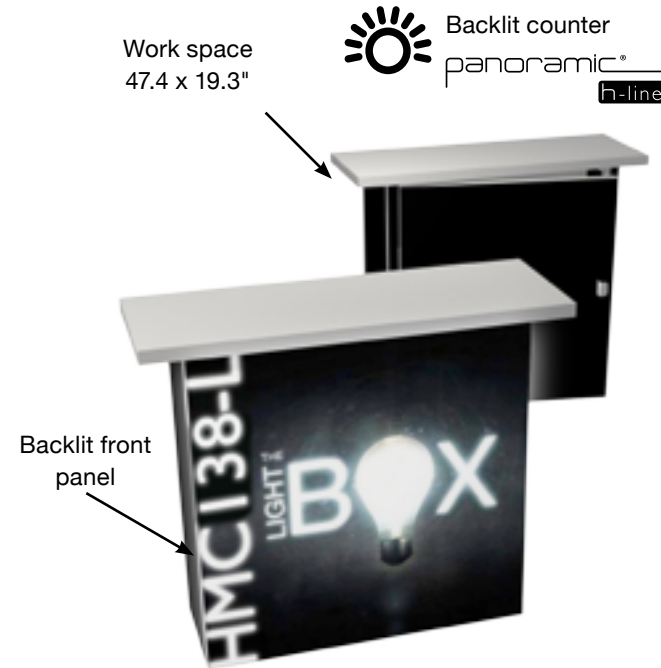

Backlit front
panel

hmc138-L

Medium counter module (38" x 38"
x 12") + dye-sub graphics

Purchase \$ **2,523**
Rental* \$ **1,044**

hmc138-L-usb

Option with USB hub

Purchase \$ **2,663**
Rental* \$ **1,086**

Counter height
39.4"

Perfect to gather around

panoramic®
C-line

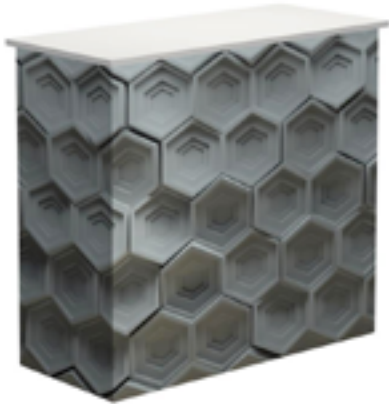

pc.04

Structure + graphic +
countertop + shelf

Purchase \$ **1,357**

Rental* \$ **639**

Counter dimensions

43.5"W x 18.5"L x 40.5"H

Countertop dimensions

30" x 19"

pc.02

Structure + graphic +
countertop

Purchase \$ **946**

Rental* \$ **463**

Counter dimensions

13"W x 13" L x 40" h

Countertop dimensions

20" x 20"

pc.10

Structure + graphic +
countertop

Purchase \$ **2,189**

Rental* \$ **1,051**

Counter dimensions

13"W x 67" L x 40" h

Countertop dimensions

69" x 28"

pc.12

Structure + graphic +
countertop + shelf

Purchase \$ **2,373**

Rental* \$ **1,073**

Counter dimensions

18"W x 64" L x 40" h

Countertop dimensions

73" x 30"

Counters are sold with booths. Please contact us for individual packaging.

*Rental price includes custom-printed graphics

TV stands, get their attention!

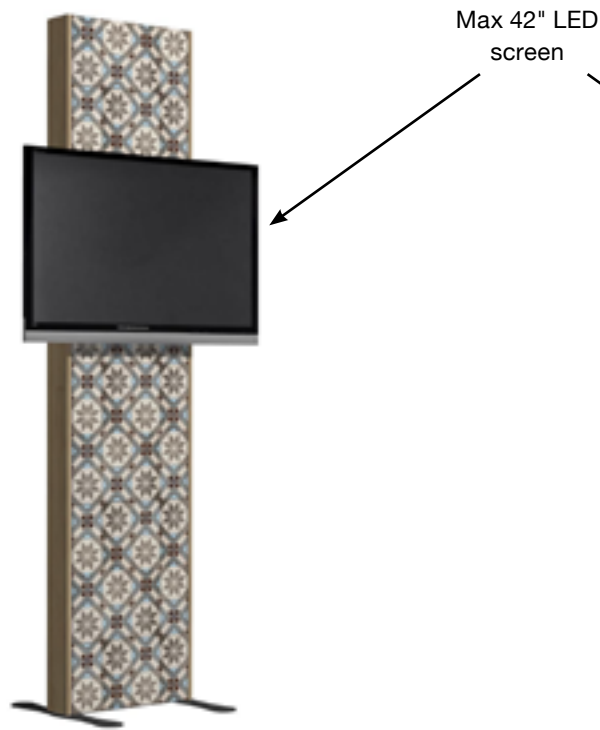

pm.04-70

Structure + graphics +
wheeled bag

Purchase* \$ **1,601**
Rental* \$ **743**

Dimensions without TV:
5" W x 21" D x 70" H

pm.04-95

Structure + graphics +
wheeled bag

Purchase* \$ **1,885**
Rental* \$ **933**

Dimensions without TV:
5"W x 21" D x 95" H

pm.07-70

Structure + graphics +
wheeled bag

Purchase* \$ **861**
Rental* \$ **310**

Dimensions without TV:
17"W x 17"D x 70"H

*TV not included. Maximum weight of TV: 44 lbs

Rental price includes custom-printed graphics

Get noticed with hanging signs

Available March 2017



- Tubular structure in anodized aluminum with a stretch fabric completely covering the structure
- Designed for exhibition booths, malls and indoor high traffic areas
- An excellent way to attract attention, promote your message and give your booth height
- Choose a square or circular sign based on the design of your booth

square.sign

8'x3'

Structure + graphic**+ bag
 Purchase \$ **3,000**
 Rental* \$ **2,230**

Dimensions :
 96" x 96" x 36"

8'x4'

Structure + graphic**+ bag
 Purchase \$ **3,675**
 Rental* \$ **2,888**

Dimensions :
 96" x 96" x 48"

10'x3'

Structure + graphic**+ bag
 Purchase \$ **3,750**
 Rental* \$ **2,805**

Dimensions :
 120" x 120" x 36"

10'x4'

Structure + graphic**+ bag
 Purchase \$ **4,575**
 Rental* \$ **3,612**

Dimensions :
 120" x 120" x 48"

circular.sign

8'x3'

Structure + graphic**+ bag
 Purchase \$ **2,525**
 Rental* \$ **1,807**

Dimensions :
 96" x 36"

8'x4'

Structure + graphic**+ bag
 Purchase \$ **3,075**
 Rental* \$ **2,322**

Dimensions :
 96" x 48"

10'x3'

Structure + graphic**+ bag
 Purchase \$ **3,200**
 Rental* \$ **2,272**

Dimensions :
 120" x 36"

10'x4'

Structure + graphic**+ bag
 Purchase \$ **3,875**
 Rental* \$ **2,912**

Dimensions :
 120" x 48"

*Rental price includes custom-printed graphics

**single-sided graphic with white or black back. Double-sided option available.

Transport solutions

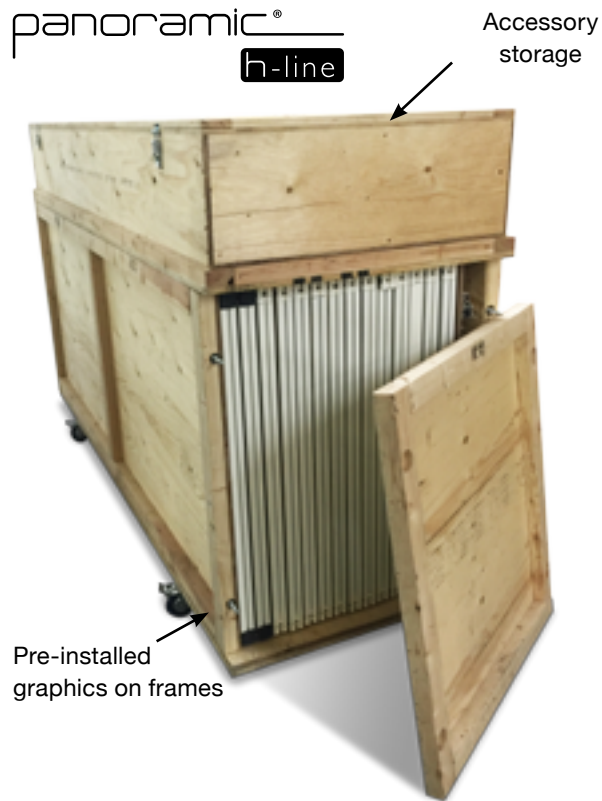

h-line.crate H3

Purchase \$ **1,250**
 Rental \$ **375**

Exterior dimensions: Weight:
 34"W x 97"L x 60"H 370 lbs



h-line.crate H5

Purchase \$ **1,250**
 Rental \$ **375**

Exterior dimensions: Weight:
 30.25"W x 96.5"L x 56.25"H 245 lbs



wood.crate

Small \$ **750**
 Medium \$ **850**
 Large \$ **950**

Exterior dimensions: Weight:
 99.5"W x 17.25"L x 27.5"H 150 lbs
 99.5"W x 30.5"L x 27.5"H 200 lbs
 99.5"W x 43.75"L x 27.5"H 250 lbs

Height includes wheels and accessory compartment



- Easy-to-transport visual solutions that are resistant, durable and easy to set up
- Pop-up booths, fabric frames, all-in-one portable kits

portable solutions

Choose a portable solution according to your needs and preferences

contour.

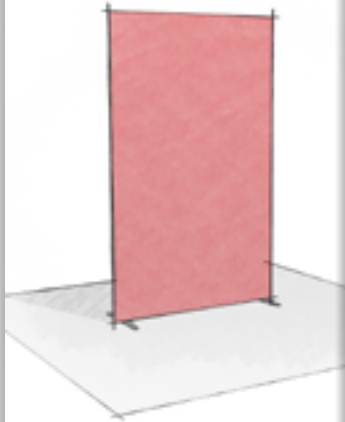

Tubular system with stretch graphic for those looking for a truly portable, modular and changeable booth solution with optional accessories. Setup time: 10 minutes.

slim, changeable design

xpressions.

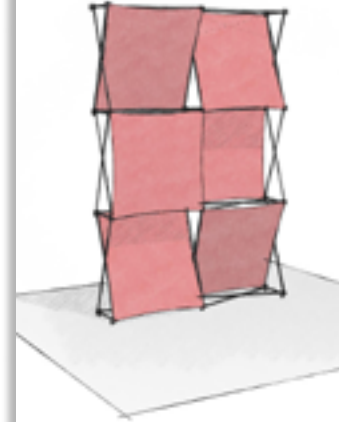

An ultra-lightweight pop-up display with several textile graphics to let you easily update your message. Available in a trade show kit as well as in a hello.xpress case. Setup time: 30 seconds

3D effect

xtension.squared

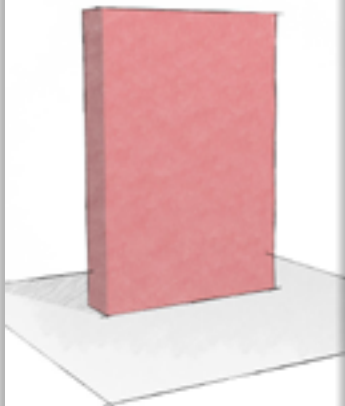

The very lightweight pop-up display with ultra-easy setup. Its right angles provide perfect rendering. Available in 5', 8' and 10'. Setup time: 60 seconds.

perfect angles

virage.



The fabric pop-up display with a curved design. Available in 8' and 10'. Setup time: 60 seconds.

curved

contour, the tubular fabric booth solution

Available March 2017



elegant design



no tools required



linking pieces between frames



wheeled transport case

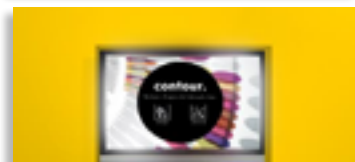

optional accessories



- A portable booth solution featuring a tubular structure covered in stretch fabric
- Lightweight and compact: 25 lbs for contour 10'x 8', transported in a wheeled bag
- Intuitive setup: No tools needed - the connectors snap into the tubes, and an instructional system is found on each frame
- Dye-sublimation printing for graphic impact: reflection-free images, intense and deep colors, wrinkle-free fabric



contour.3'x8'

Structure + graphic* +
wheeled transport case
Purchase \$ **1,000**

Dimensions :
36"x92"



contour.5'x8'

Structure + graphic* +
wheeled transport case
Purchase \$ **1,290**

Dimensions :
57"x92"



contour.8'x8'

Structure + graphic* +
wheeled transport case
Purchase \$ **1,785**

Dimensions :
92"x92"



contour.10'x8'

Structure + graphic* +
wheeled transport case
Purchase \$ **2,250**

Dimensions :
114"x92"



contour.20'x8'

Structure + graphic* +
wheeled transport case
Purchase \$ **4,475**

Dimensions :
228"x92"



contour.3'x10'

Structure + graphic* +
wheeled transport case
Purchase \$ **1,260**

Dimensions :
36"x126"

*Single-sided graphic with white or black back. Double-sided option available.

Create your custom configuration

contour is a changeable, modular and functional solution: add a TV, spotlights, and connect several frames together at 45°, 90° or 180° angles!

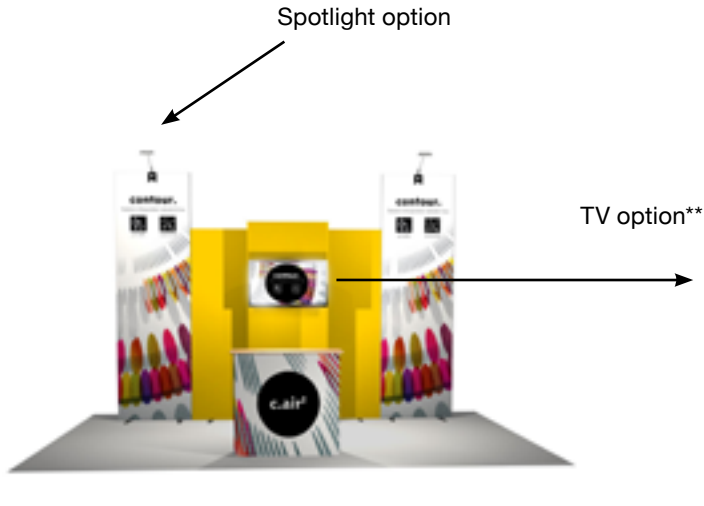

Purchase* **\$ 6,725**

*excludes TV screen

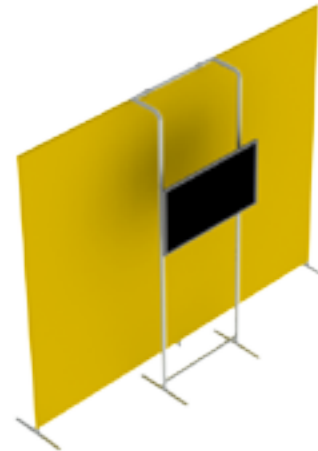

Purchase **\$ 7,230**



Purchase **\$ 7,160**



Purchase **\$ 13,200**



Purchase **\$ 8,660**

**TV mounting bracket included. Does not include TV screen.

xpressions, the most creative and original pop-up

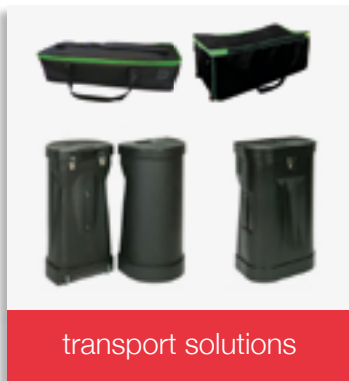
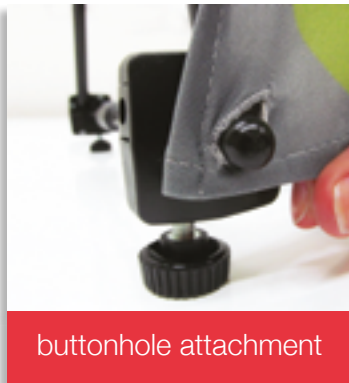

- Ultra-light aluminium frame and powerful magnetic connectors allow the frame to open up automatically
- Buttonhole attachment system makes it easy to replace graphics to suit your audience or needs
- Originality is guaranteed thanks to its multiple 3D graphics combinations
- Make your booth unique with a selection of accessories: lights, shelves, soft bag or hard case-counter
- 5 year warranty



xpressions.2.5' (1x3)

Structure + graphics + 1 shelf + soft transport bag

Qty 1	\$ 775
Qty 3	\$ 756
Qty 6	\$ 744

Quantity and dimensions of graphics
3 1 x 1 graphics

xpressions.5' (2x3)

Structure + graphics + 1 shelf + soft transport bag

Qty 1	\$ 1,240
Qty 3	\$ 1,217
Qty 6	\$ 1,203

Quantity and dimensions of graphics
6 1 x 1 graphics

xpressions.8' (3x3)

Structure + graphics + 1 shelf + soft transport bag

Qty 1	\$ 1,730
Qty 3	\$ 1,702
Qty 6	\$ 1,685

Quantity and dimensions of graphics
9 1 x 1 graphics

xpressions, the most creative and original pop-up



xpressions.10' (4x3)

Structure + graphics + wheeled transport bag

Qty 1	\$ 2,506
Qty 3	\$ 2,470
Qty 6	\$ 2,449

Quantity and dimensions of graphics

8 1 x 1 graphics, 1 diamond graphic, 1 2 x 2 graphic

xpressions.7' (pyramideS)

Structure + graphics + soft transport bag

Qty 1	\$ 700
Qty 3	\$ 685
Qty 6	\$ 675

Quantity and dimensions of graphics

3 1 x 1 graphics

xpressions.10.5' (argyle)

Structure + graphics + soft transport bag

Qty 1	\$ 2,083
Qty 3	\$ 2,053
Qty 6	\$ 2,034

Quantity and dimensions of graphics

6 1 x 1 graphics, 1 triple diamond graphic

xpressions accessories



Rectangular shelf
11.5" x 27.5" \$ **75**



Square shelf
11.68" x 11.25" \$ **60**



Triangular shelf
11.5" x 11.5" x 11.5" \$ **70**

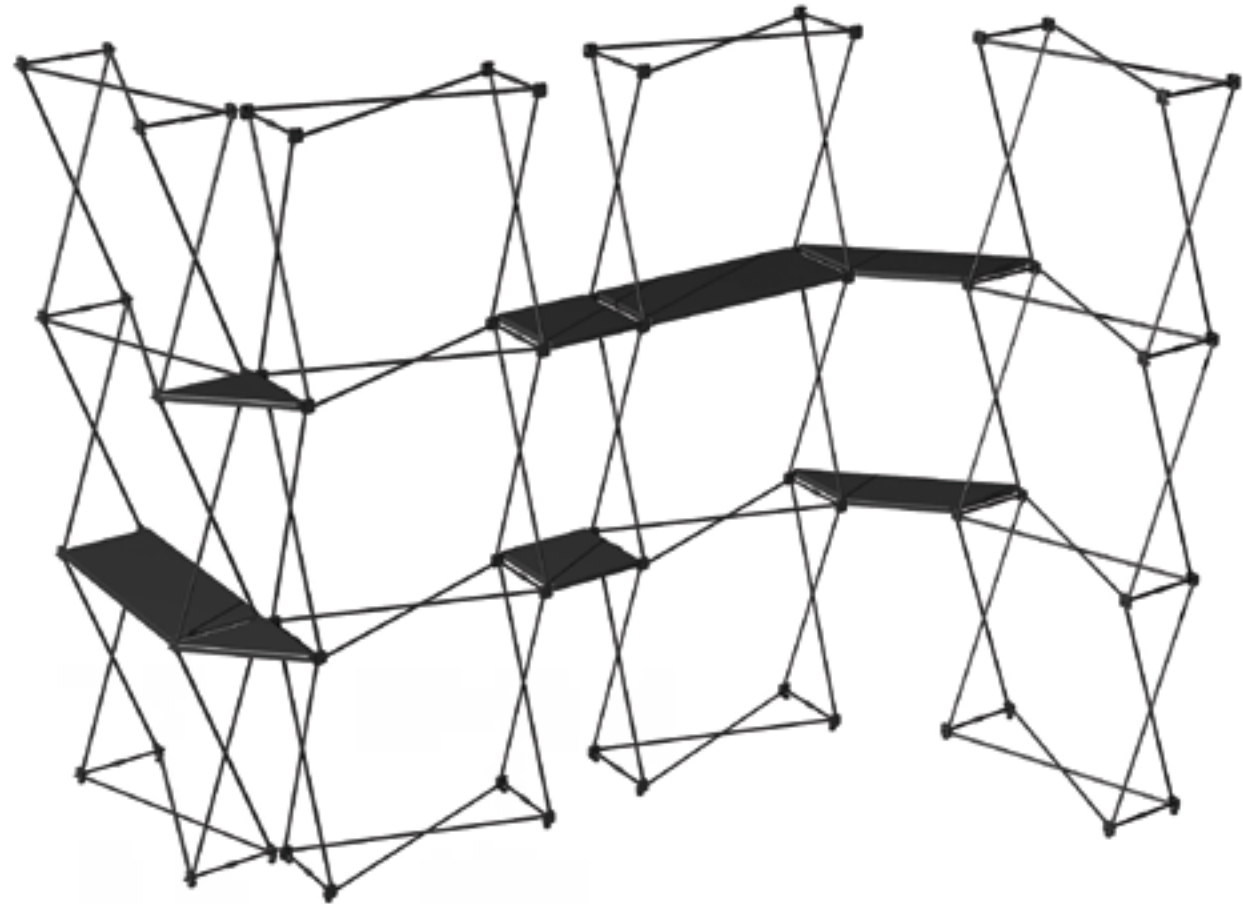

Connect your structures with shelves to create new configurations

hello.xpress, the all-in-one exhibit solution

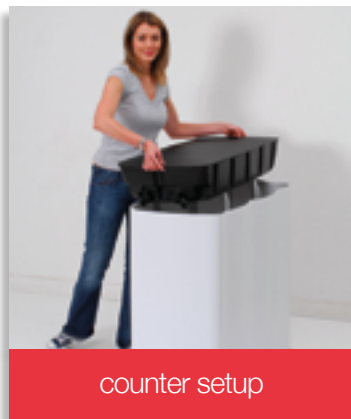

- Lightweight and practical solution, ideal for an 8' x 8' booth space
- The hard transport case turns into a counter that is equipped with a storage space
- Unfold, set up and tear down 8' booth on your own in less than 10 minutes
- Change a part of a graphic without changing the entire fabric wall

Option

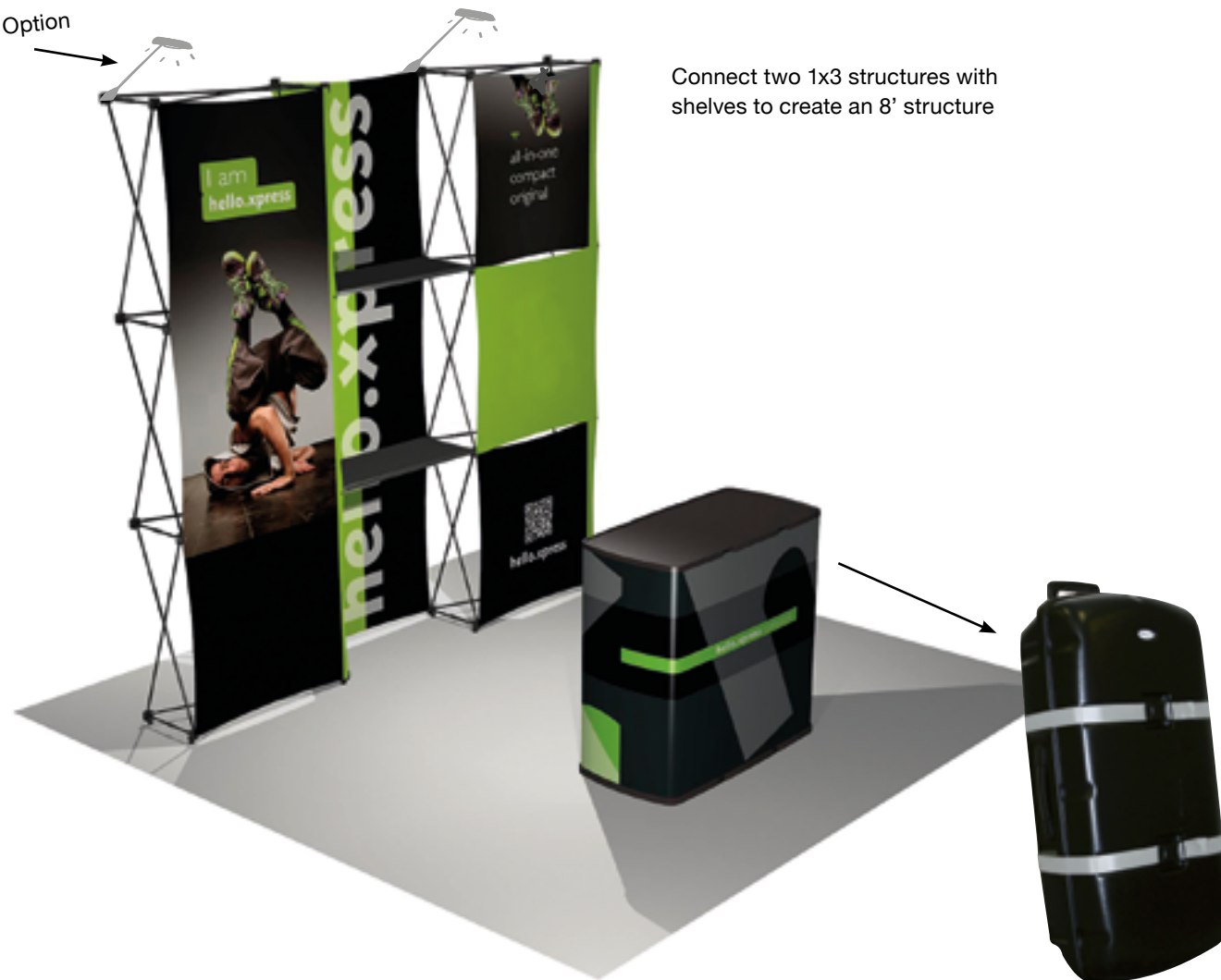

Connect two 1x3 structures with shelves to create an 8' structure

hello.xpress 8'

Structure (2 xpressions 1x3 + 2 shelves) + graphics + case to counter

Qty 1	\$ 2,896
Qty 3	\$ 2,805
Qty 6	\$ 2,769

Quantity and dimensions of graphics:

- 2 graphics 1x3
- 3 graphics 1x1
- 1 counter graphic

Each kit fits into a single suitcase that transforms into a counter!

xtension.squared, the perfectly squared fabric pop-up

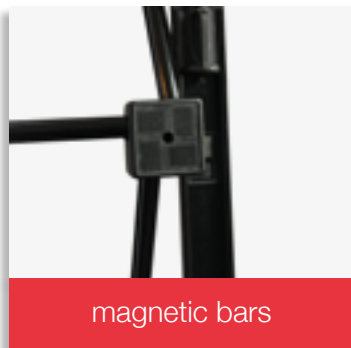
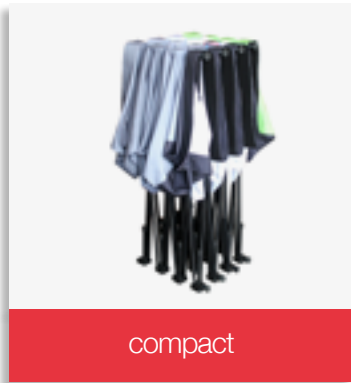

- Lightest solution on the market: 19 lbs for a 10' xtension.squared (structure + graphic)
- Sets up in less than a minute
- Exceptional image rendering provided by dye-sublimation fabric printing
- Perfect fabric tension, adjusted to the frame thanks to the magnetic bars: clean, sharp edges

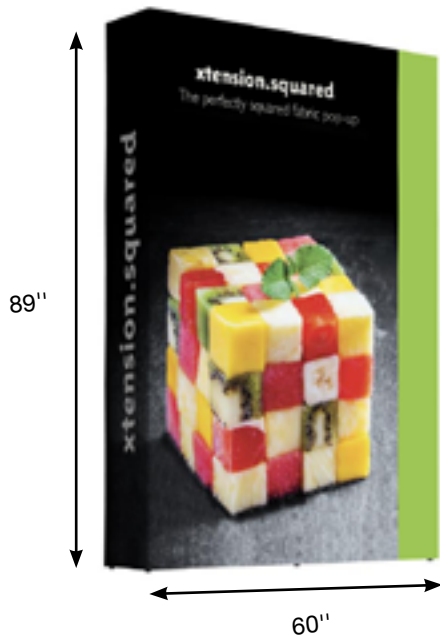

xtension.squared 5' (2x3)

Structure + graphic + packaging

	bag*	M case-counter**
Qty 1	\$ 1,090	\$ 1,530
Qty 3	\$ 1,075	\$ 1,500
Qty 6	\$ 1,061	\$ 1,478

Graphic dimensions

89.76" x 87" with end caps



xtension.squared 8' (3x3)

Structure + graphic + packaging

	bag*	M case-counter**
Qty 1	\$ 1,390	\$ 1,830
Qty 3	\$ 1,373	\$ 1,798
Qty 6	\$ 1,357	\$ 1,774

Graphic dimensions

118.8" x 87" with end caps

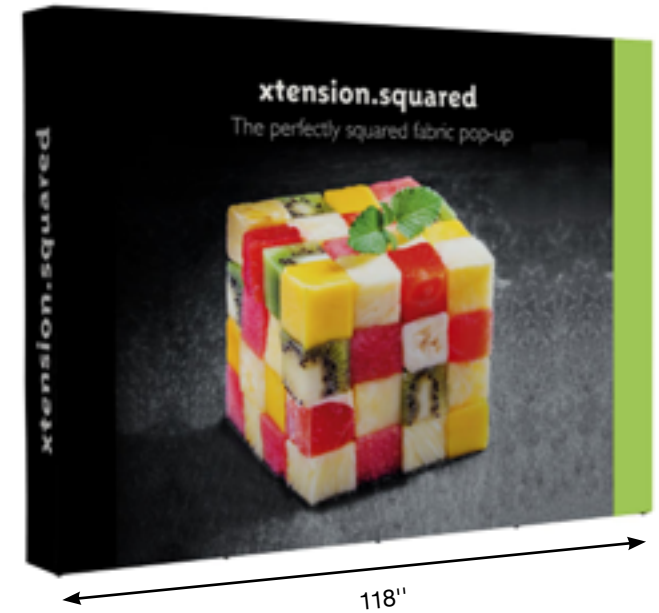

xtension.squared 10' (4x3)

Structure + graphic + packaging

	bag***	M case-counter**
Qty 1	\$ 1,745	\$ 2,130
Qty 3	\$ 1,723	\$ 2,096
Qty 6	\$ 1,704	\$ 2,070

Graphic dimensions

148" x 87" with end caps

*soft transport bag **case-counter with graphic (wood countertop included) ***wheeled transport bag

xtension.squared, the perfectly squared fabric pop-up

The perfect solution for your events!

Create a modular 20 foot booth using one 10' (4x3) xtension.squared frame and two 5' (2x3)



xtension.squared

The modular 20' booth:
Two 5' (2x3) frames with graphics + one 10' (4x3) frame with graphics + 1 large convertible case with podium top and graphic

Purchase \$ **4,370**

virage, the curved backwall

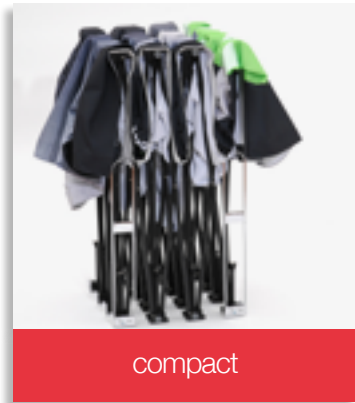

compact



auto-gripping pads



case-counter

- Curved structure that sets up in less than 1 minute thanks to a combination of clipping fasteners and magnetic connectors
- The fabric graphic stays attached to the frame even when folded up, making setup quick and easy

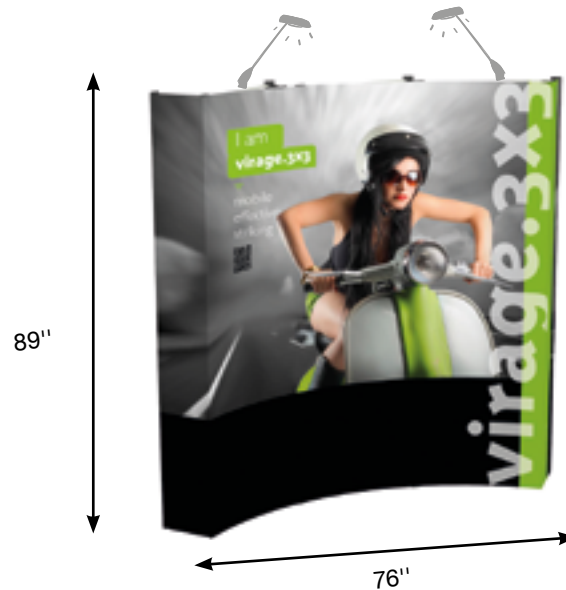

virage.8' (3x3)

Curved structure + graphics + packaging

	bag*	L case - counter**
Qty 1	\$ 1,490	\$ 1,980
Qty 3	\$ 1,470	\$ 1,946
Qty 6	\$ 1,453	\$ 1,922

Graphic dimensions

109.84" x 85.43" with end caps

*XL wheeled transport bag

- The graphic is always held taut by auto-gripping pads
- The hard transport case turns into a counter

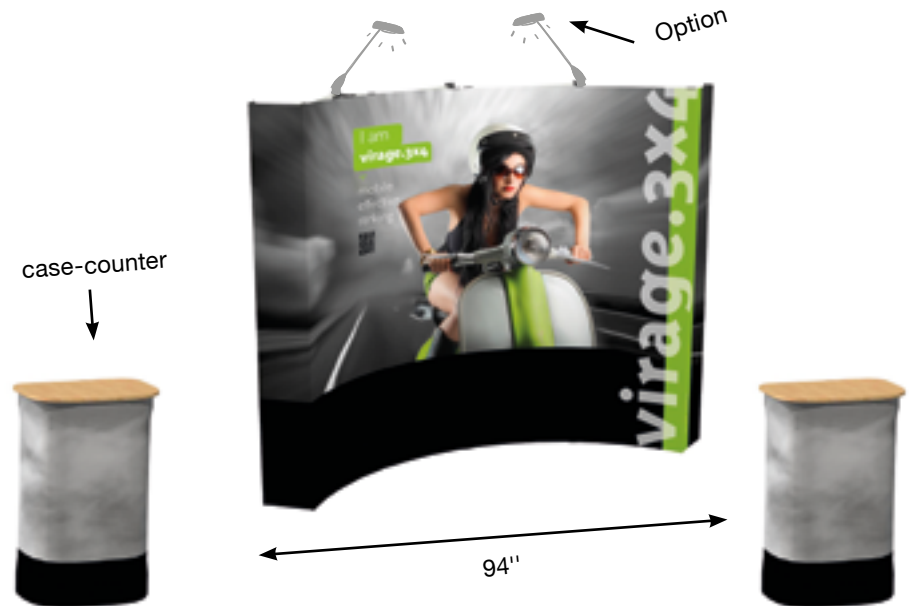

virage.10' (4x3)

Curved structure + graphics + packaging

	bag*	L case - counter**
Qty 1	\$ 1,790	\$ 2,280
Qty 3	\$ 1,768	\$ 2,244
Qty 6	\$ 1,749	\$ 2,218

Dimensions visual

136.41" x 85.43" with end caps

**L case-counter with graphics (wood countertop included)

c.air², the most effective fabric pop-up counter



compact



transport bag



shelf and countertop

- Instant and easy setup
- Lightweight and practical solution : 20 lbs for the whole kit (frame + graphic + countertop + shelf + packaging)
- Attractive: high-quality color execution, perfectly taut graphic
- Countertop and interior shelf made of lightweight and sturdy bamboo
- Shipped in a transport bag with internal compartments, easily transportable

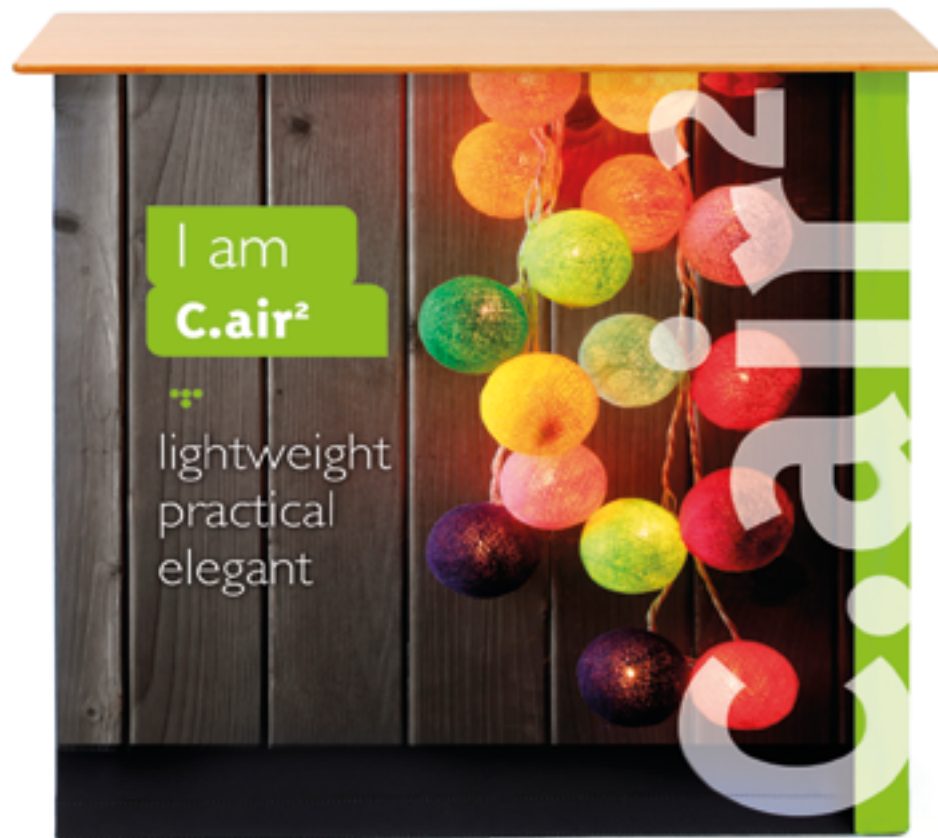

42"

C.air²

Structure + graphic + countertop + shelf + transport bag

Qty 1	\$ 655
Qty 3	\$ 634
Qty 6	\$ 621

Countertop dimensions
15.75" x 42"

Shelf dimensions
11.5" x 38.5"

Counter height
39.5"

Graphic dimensions
70.86" x 37.79" with end caps



<11 lbs

Weight



<5 mins

Setup time



on foot
car
subway
train
airplane

Transport

- Lightweight visual solutions, easy to set up and transport
- Retractable, banner stands

ultra-portable solutions

Choose your ultra-portable solution according to your needs

		Type	Width	Max. height	Pole	Bag included	Light compatible	Graphic replacement system	Double-sided
	one.R1	Retractable	31.5"	79"	Fixed	x	x	-	
	axis	Retractable	23.5" / 33.25"	30" - 79"	Telescopic	x	x	Easy-change and clipping hanger	
	supreme1	Retractable	33.25" / 39.25" / 47"	33" - 84.5"	Telescopic	x	x	Internal cartridge and clipping hanger	
	lite.banner	Non-retractable	23.5" / 33.25" / 39.25" / 47"	60" - 84.5"	Telescopic	x	x	Clipping hangers	
	one.R2	Retractable	31.5"	79"	Fixed	x		-	x
	supreme2	Retractable	33.25"	84.5"	Fixed	x		Internal cartridge and clipping hanger	x

one, the low-cost no-compromise banner stand



- The assurance of buying a reliable solution at the best price, without compromising on quality
- Three-piece, non-telescopic pole is stored inside the casing



Option
single-sided

one.R1

Structure + graphic + transport bag
Qty 1 \$ **170**

Graphic dimensions
31.10" x 79.76"

- Two options: single or double-sided for more dynamic communication
- Transport bag included



double-sided

The double-sided display makes it the ideal tool for spreading your message in high

one.R2

Structure + 2 graphics + transport bag
Qty 1 \$ **340**

Graphic dimensions
31.10" x 79.76"

axis, the lightweight and compact retractable



clipping hanger



telescopic pole

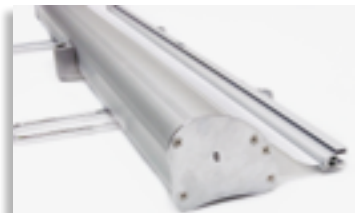

stabilizing feet



transport bag

- The telescopic pole allows for an easy set up and can reach up to 79" in height
- Retractable, self-locking stabilizing feet provide perfect stability
- The clipping hanger and easy-change system allow you to switch out the graphics yourself
- Transport bag included



axis.23"

Structure + graphic + transport bag

Qty 1	\$ 281
Qty 3	\$ 273
Qty 6	\$ 269

Graphic dimensions

23.5" x 79"



axis.33"

Structure + graphic + transport bag

Qty 1	\$ 340
Qty 3	\$ 332
Qty 6	\$ 326

Graphic dimensions

33.25" x 79"

supreme, the utterly practical, road-warrior retractable

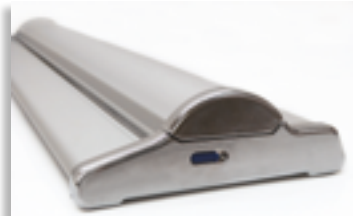

single-sided supreme

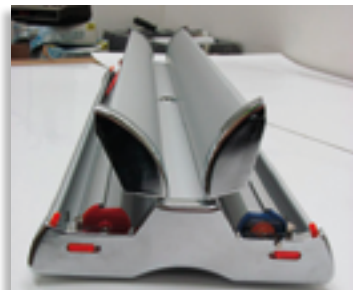

double-sided supreme



internal cartridge



transport bag

- The easy-open base with its removable roller makes changing graphics a snap
- Available in single- or double-sided versions

- The telescopic pole is easy to set up and reaches up to 84.5" in height
- Transport bag included



double-sided

supreme.1

Structure + graphic
+ transport bag

	33"	39"	47"
Qty 1	\$ 485	\$ 545	\$ 634
Qty 3	\$ 469	\$ 528	\$ 614
Qty 6	\$ 460	\$ 517	\$ 602

Graphic dimensions

33.25" x 84.5"

39.25" x 84.5"

47" x 84.5"

supreme.2

Structure + graphic
+ transport bag

	33"
Qty 1	735 \$
Qty 3	715 \$
Qty 6	703 \$

Graphic dimensions

33.25" x 84.5"

lite.banner, an invisible frame makes your graphic stand out

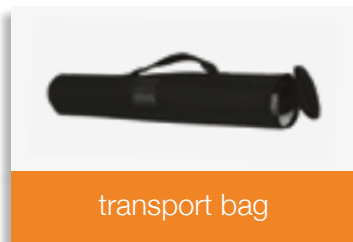

- "L-shaped" structure with stable, attractive base
- Telescopic pole to adjust the height of the graphic (up to 84.5")

- Clipping hangers allow you to switch out the graphics yourself
- Optional lighting available



lite.banner

Structure + graphic + transport bag

	23"	33"	39"	47"
Qty 1	\$ 251	\$ 308	\$ 345	\$ 403
Qty 3	\$ 245	\$ 310	\$ 338	\$ 395
Qty 6	\$ 241	\$ 297	\$ 333	\$ 390

Graphic dimensions

23.5" x 84.5"

33.25" x 84.5"

39.25" x 84.5"

47" x 84.5"



<11 lbs

Weight



<5 mins

Setup time



car
subway
train
airplane

Transport

- Designed and tested to withstand outdoor conditions: sun, wind, rain, snow...
- Weight optimized for transport. Base system for additional ballast.
- Easy set-up

outdoor solutions

flags, outdoor communication



cross base



steel base plate

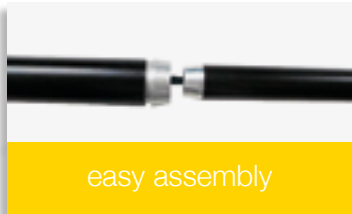

easy assembly

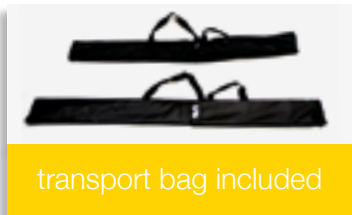

transport bag included



- Guaranteed visibility even in the absence of wind
- Dye-sublimation printing for high-definition quality and exceptional resistance to UV rays
- A rotating axis on bearings increases durability and lengthens the life of the flag
- High resistance e-glass tubes connected by an elastic band
- Easily replace your graphic with without changing the structure

Single-sided



Additional accessories available
(ballast, cross base, ground spike, etc.)



flag.plume

Structure + graphic + base plate

Size	S	L	XL
Height	7 ft	10 ft	15 ft
Base	(11 lbs)	(22 lbs)	(33 lbs)
Qty 1	\$ 265	\$ 502	\$ 685
Qty 3	\$ 258	\$ 492	\$ 672
Qty 6	\$ 253	\$ 486	\$ 664

Graphic dimensions

27.55" x 63" 41.53" x 105.5" 45.47" x 134.25"

flag.sea

Structure + graphic + base plate

Size	S	L	XL
Height	8 ft	11 ft	15 ft
Base	(11 lbs)	(22 lbs)	(33 lbs)
Qty 1	\$ 278	\$ 396	\$ 590
Qty 3	\$ 271	\$ 386	\$ 577
Qty 6	\$ 266	\$ 380	\$ 569

Graphic dimensions

25.59" x 84.65" 27.56" x 110.24" 31.5" x 157.48"

flag.hit

Structure + graphic + base plate

Size	S	L	XL
Height	7 ft	10 ft	13 ft
Base	(11 lbs)	(22 lbs)	(33 lbs)
Qty 1	\$ 290	\$ 398	\$ 571
Qty 3	\$ 281	\$ 387	\$ 556
Qty 6	\$ 276	\$ 381	\$ 548

Graphic dimensions

27.95" x 63" 27.95" x 98.42" 27.95" x 143.7"

Double-sided



Additional accessories available
(ballast, cross base, ground spike, etc.)



flag.plume

Structure + graphic + base plate

Size	S	L	XL
Height	7 ft	10 ft	15 ft
Base	(11 lbs)	(22 lbs)	(33 lbs)
Qty 1	\$ 384	\$ 808	\$ 1,106
Qty 3	\$ 377	\$ 798	\$ 1,093
Qty 6	\$ 372	\$ 792	\$ 1,085

Graphic dimensions

27.55" x 63" 41.53" x 105.5" 45.47" x 134.25"

flag.sea

Structure + graphic + base plate

Size	S	L	XL
Height	8 ft	11 ft	15 ft
Base	(11 lbs)	(22 lbs)	(33 lbs)
Qty 1	\$ 410	\$ 596	\$ 916
Qty 3	\$ 403	\$ 586	\$ 903
Qty 6	\$ 398	\$ 580	\$ 895

Graphic dimensions

25.59" x 84.65" 27.56" x 110.24" 31.5" x 157.48"

flag.hit

Structure + graphic + base plate

Size	S	L	XL
Height	7 ft	10 ft	13 ft
Base	(11 lbs)	(22 lbs)	(33 lbs)
Qty 1	\$ 406	\$ 579	\$ 846
Qty 3	\$ 397	\$ 568	\$ 831
Qty 6	\$ 392	\$ 562	\$ 823

Graphic dimensions

27.95" x 63" 27.95" x 98.42" 27.95" x 143.7"



<40 lbs

Weight



<15 mins

Setup time



car
train
airplane
courier

Transport

- Large-format wall frames, lightboxes, free-standing frames
- High-impact visual solutions, easy to set up and transport
- Prints up to 20' wide

fabric frames

wall.frame, very large format wall-mounted frames



easy to insert



silicone edge



interior decor



boutique decor



- High-definition design and quality: a nearly invisible frame edge, perfectly taut graphic fits to the frame, and unrivaled color execution thanks to dye-sublimation printed fabric
- Adapts to all uses thanks to round or right-angle corners
- Ultra-light frame, easy to change graphics that attach thanks to silicone edges
- No tools required

Price includes frame + brackets + (right-angle or rounded) + dye-sublimated fabric graphics

H/L	2'	3'	4'	5'	6'	7'	8'	9'	10'	11'	12'	13'	14'	15'	16'	17'	18'	19'	20'
2'	\$210	\$252	\$294	\$336	\$378	\$469	\$519	\$561	\$603	\$645	\$687	\$745	\$836	\$878	\$920	\$962	\$1 020	\$1 062	\$1 104
3'	\$268	\$325	\$382	\$439	\$496	\$602	\$667	\$724	\$781	\$838	\$895	\$968	\$1 074	\$1 131	\$1 188	\$1 245	\$1 318	\$1 375	\$1 432
4'	\$310	\$382	\$454	\$526	\$598	\$719	\$799	\$871	\$943	\$1 015	\$1 087	\$1 175	\$1 296	\$1 368	\$1 440	\$1 512	\$1 600	\$1 672	\$1 744
5'	\$352	\$439	\$526	\$613	\$700	\$836	\$931	\$1 018	\$1 105	\$1 192	\$1 279	\$1 382	\$1 518	\$1 605	\$1 692	\$1 779	\$1 882	\$1 969	\$2 056
6'	\$394	\$496	\$598	\$700	\$802	\$953	\$1 063	\$1 165	\$1 267	\$1 369	\$1 471	\$1 589	\$1 740	\$1 842	\$1 944	\$2 046	\$2 164	\$2 266	\$2 368
7'	\$485	\$602	\$719	\$836	\$953	\$1 119	\$1 244	\$1 361	\$1 478	\$1 595	\$1 712	\$1 845	\$2 011	\$2 128	\$2 245	\$2 362	\$2 495	\$2 612	\$2 729
8'	\$543	\$675	\$807	\$939	\$1 071	\$1 252	\$1 392	\$1 524	\$1 656	\$1 788	\$1 920	\$2 068	\$2 249	\$2 381	\$2 513	\$2 645	\$2 793	\$2 925	\$3 057

Dimensions in feet - Pricing based on EASY-STRETCH fabric - cardboard packaging included



wall.frame

Teardrop
(2 rounded + 2 right-angle corners)

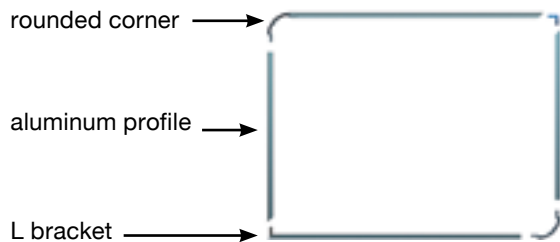

wall.frame

Contour
(4 rounded corners)

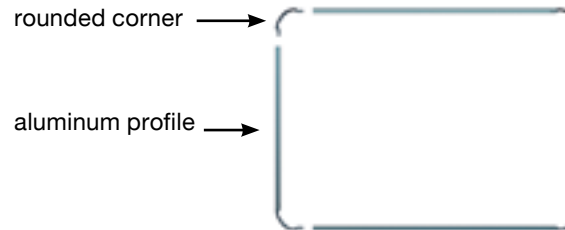

wall.frame

Classic
(4 right-angle corners)

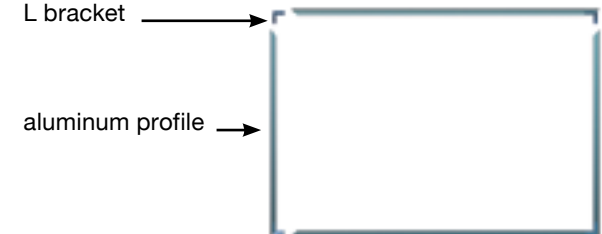

Lightbox, for even more impact

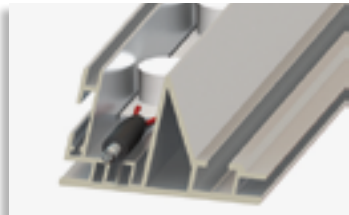

single-sided profile

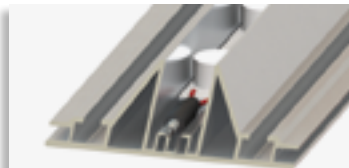

double-sided profile



LED integrated into the profile



free-standing frame



- Light is evenly diffused
- Color execution is unrivaled thanks to dye-sublimation printed fabric
- Eco-friendly: LED light system with low energy consumption
- Suited to exhibit and event conditions, ideal for in-store decoration
- Seamless integration with panoramic booths

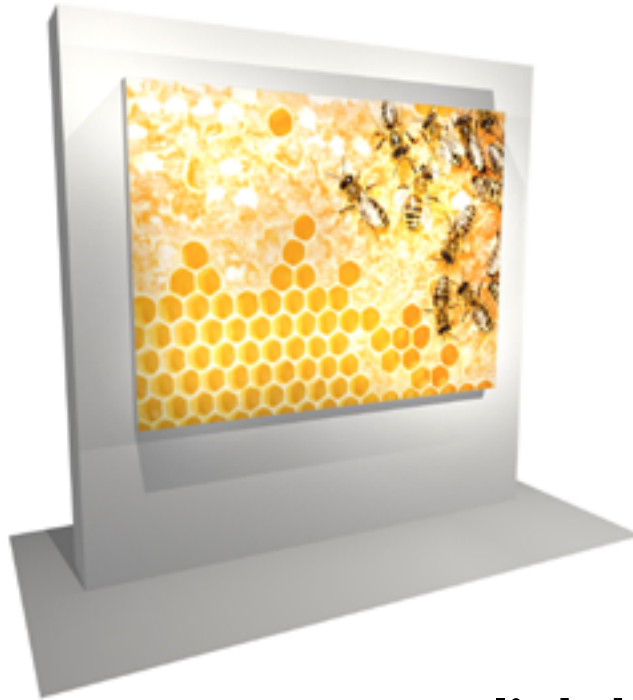

lightbox.

Wall-mounted lightbox

WALL-MOUNTED

H/L	5'	8'	10'	20'
5'	\$1 985	\$2 866	\$3 897	\$7 031
6'	\$2 138	\$3 091	\$4 172	\$7 536
7'	\$2 291	\$3 316	\$4 447	\$8 041
8'	\$2 443	\$3 541	\$4 722	\$8 546



lightbox.

Free-standing lightbox

FREE-STANDING SINGLE-SIDED

H/L	5'	8'	10'	20'
5'	\$1 985	\$2 866	\$3 927	\$7 121
6'	\$2 138	\$3 091	\$4 202	\$7 626
7'	\$2 291	\$3 316	\$4 477	\$8 131
8'	\$2 443	\$3 541	\$4 752	\$8 636

FREE-STANDING DOUBLE-SIDED

H/L	5'	8'	10'	20'
5'	\$2 427	\$3 492	\$4 687	\$8 509
6'	\$2 641	\$3 801	\$5 061	\$9 188
7'	\$2 855	\$4 110	\$5 435	\$9 867
8'	\$3 069	\$4 419	\$5 809	\$10 546

Prices calculated using LIGHTEX fabric - Cardboard packaging included



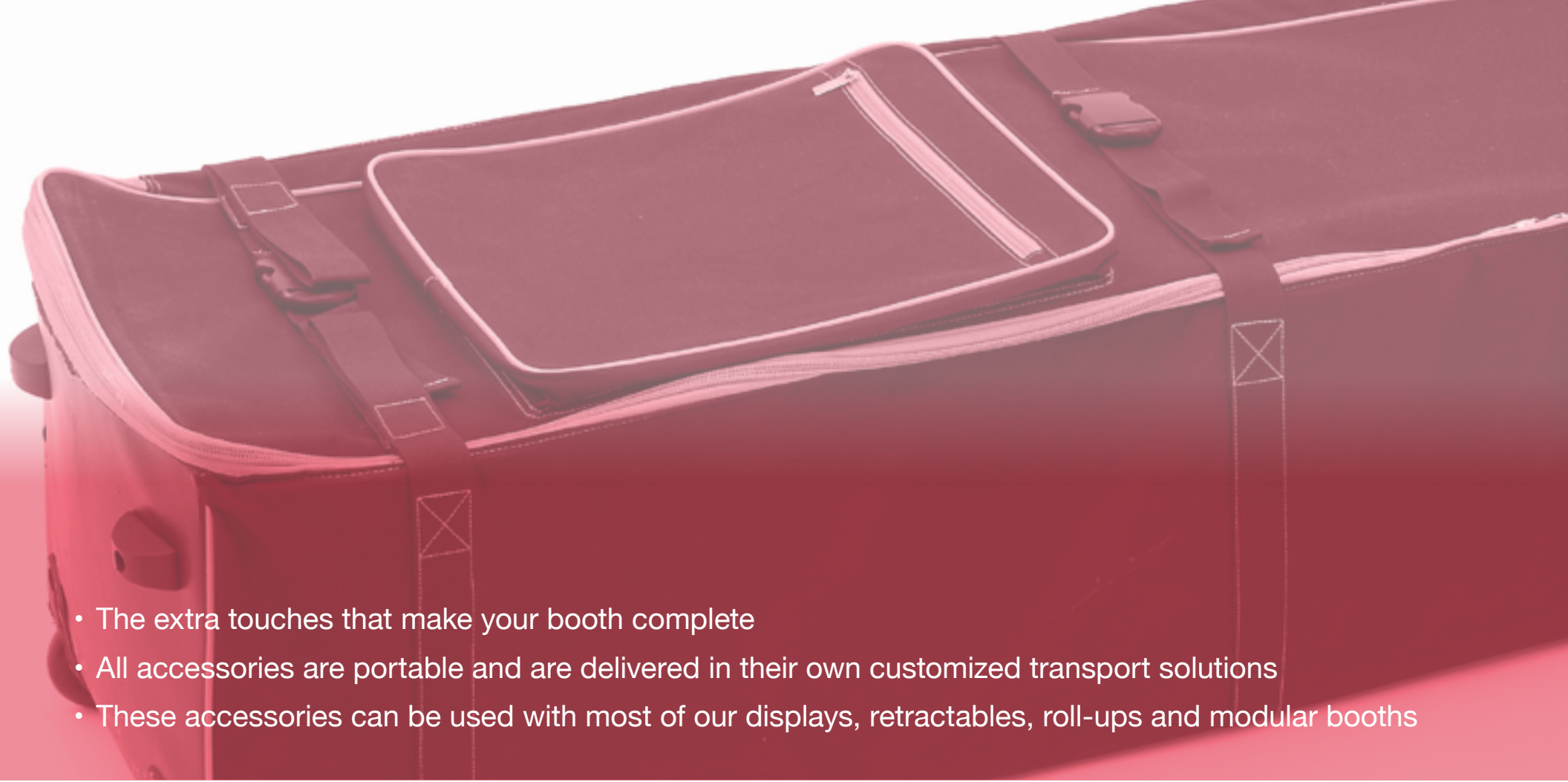

- The extra touches that make your booth complete
- All accessories are portable and are delivered in their own customized transport solutions
- These accessories can be used with most of our displays, retractables, roll-ups and modular booths

accessories & packaging

Lighting



light attached to panoramic profile

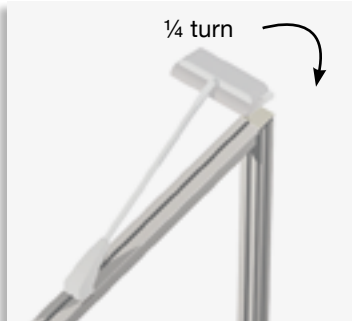

easy to attach



LED COB Technology
The LED light has the same performance as a halogen light yet consumes much less energy!



spot.led

LED light (transport bag included) \$ **135**

Brochure holders & display cases



mesh.4

Brochure holder with 4 fabric pockets (transport bag included)

Purchase \$ **80**



mesh.8

Brochure holder with 8 fabric pockets (transport bag included)

Purchase \$ **95**



holdup.classic

Brochure holder with 4 polycarbonate pockets (transport bag included)

Purchase \$ **399**



helix.200

Large illuminated foldable display case with 4 shelves and 16 transparent panels

Purchase \$ **1,450**

Dimensions :
Ø44" x 78.7"

Available April 2017



helix.106

Small foldable counter display case with 2 shelves and 8 transparent panels

Purchase \$ **695**

Dimensions :
Ø22.8" x 41.7"

Available March 2017

Bags



soft.transport bag

TRB013 \$ **60**

Dimensions :

Interior: 34" x 9.5" x 7"

Exterior: 34.5" x 10" x 8.5"

Weight: 1.5 lbs



wheeled.transport bag

TRB018 \$ **115**

Dimensions :

Interior: 31.4" x 11" x 10.8"

Exterior: 33" x 11.8" x 11"

Weight: 1.4 lbs

Available February 2017



xl.wheeled transport bag

TRB015 \$ **190**

Dimensions :

Interior: 34.5" x 16.5" x 11.5"

Exterior: 35" x 17" x 12"

Weight: 8.5 lbs

Which transport solution should you choose?

		Soft bag	Wheeled transport bag		Case-counter	
		TRB013	TRB018	TRB015	TRT001	TRT002
					M	L
expressions.	(max.4x3)	•	•	•	•	•
expressions.	(>4x3)		•	•	•	•
xtension.	(max.3x4)	•	•	•	•	•
virage.	3x3			•		•
virage.	3x4			•		•



hard case.M counter

TRT001 \$ 500

Complete kit includes:

- Hard case (TRT001) \$ 220
- Wood countertop \$ 130
- Graphic \$ 150

Dimensions counter

14.5" L x 15.5" W x 35"H



hard case.L counter

TRT002 \$ 680

Complete kit includes:

- Hard case (TRT002) \$ 295
- Wood countertop \$ 150
- Graphic \$ 235

Dimensions counter

24" L x 15.5" W x 38"H

Stand out from the crowd with a personalized, high-impact booth.

Our booth solutions, especially those from the panoramic line, are designed to highlight printed images. Here are a few creative tips to maximize your visual effectiveness.

- Opt for an immersive design

Optical illusion effects, textures, high-resolution and large-format graphics, graphic personalization of the entire surface including the floor...these are just some of the ways you can immerse your visitor in your booth's environment.

- Focus on a simple graphic and a unique message

Trade show visitors have less than 30 seconds of attention to give you when they pass by your booth. The easiest message for them to understand is a simple message set against a sleek graphic background. Try to avoid using too many messages, colors or effects, as impact is created through simplicity.

- Combine continuous design with modularity

Your modular booth will evolve as you attend various trade shows and share different messages. The languages of your event may even vary. Don't hesitate to adapt its design as necessary. We guarantee perfect graphic continuity, even if your booth is sectioned into panels.



To create your graphics, please refer to the provided templates to create the appropriate files, and contact our operators at the start of your project. You will then be guided through our xpo.center file management platform.

Four reasons to attend a trade show

- Meet decision-makers

According to Exhibit Surveys, in 2010, 80% of trade show visitors had "the power to recommend or make final purchase decisions". In addition, 31% of visitors claimed that "their purchase intention was stronger after visiting the trade show".

- Improve sales productivity

According to the French Statistical Audit Bureau for General and Specialised Fairs and Exhibitions (OJS), customer contact at a trade show is "four to ten times less expensive than a customer visit". Contact cost for a stand averages at about 20 \$, whereas this contact ranges from 80 à 200 \$ when made during field visits. Furthermore, a sales rep will meet with 15 customers daily at a trade show vs. an average of three customers during a field visit.

- Explore prospects

Trade shows hold a wealth of opportunities and present many "hot" receptive prospects because visitors attend shows on their own accord. This makes it an incredibly effective way for exhibitors to expand their customer base

- Communicate with the press and opinion leaders



Tips & tricks for making your trade show a success

Before the show

- Create a budget and set goals

Trade show participation is part of a company's overall strategy, as well as its marketing, sales and HR strategies. It is very important to set specific goals and create a budget that includes purchasing of space, a booth, as well as personnel costs (travel, hotels, restaurants). It is essential to create a system for gauging the success of each trade show.

- Select trade shows that your company wants to attend, then choose your placement and area size

A countless array of events exist, ranging from major international trade shows to local conventions. It is important that each trade show you attend corresponds to your company's challenges in terms of business. Many companies now prefer to attend local trade shows with small exhibit areas as they offer more returns on investment. Trade show organizers often offer pre-registration discounts, so it is best to reserve exhibit space in advance. Placement is also a very important factor. Opt for placement near the entrance, in the main aisles or near "locomotives" (leading companies that attract visitors).

- Seek assistance of trade show display and visual communication professionals

Exhibits and event planning are very specific fields and require experience. Seek the advice of professionals, and do not hesitate to ask your service provider questions on how to set up your booth and who will be involved. You may also request references and contact them.

- Create a brief for trade show display professionals

Clearly explain your objectives and your strategy. Several constraints may influence your trade show display specialist's recommendations, which can help you cut costs significantly.

What type of booth should you choose? We have divided booths into three categories based on their weight, volume and assembly time/difficulty. The categories are: ultra-portable, portable and transportable. All ultra-portable and portable solutions may be set up and dismantled by exhibitors without any professional assistance. Some transportable booths also have the "Do it yourself" label.

How many times will you use your booth? If you will only use your booth once, opt for a rental. If you will reuse it several times, specify the various spaces where it will be used and your desired configurations. It is possible to start with a modular system that uses shared elements, which will allow you to create exhibits ranging in a wide variety of sizes.

Which features do you need? Reception counters, storage, product displays, videos, customer meetings, brochure distribution.... these are all features that influence how your booth is designed.

- Invite your customers and prospective customers

Trade show organizers provide free passes and distribute newsletters, which will allow you to easily inform your customers about your participation. Sales teams can also increase their scope of action by meeting with customers before and after the trade show for breakfast or dinner. Remember that these times are just as effective as field visits.

During the trade show

- Details make the difference

Your booth is a reflection of your company's image. Make sure it is organized! A storage area is very useful for concealing packaging or for storing brochures. Portable solutions come with a carrying case that turns into a counter, and modular solutions offer storage areas that are secured by a door. Lighting is very important as it puts the spotlight on your message. Environmentally-friendly LED solutions help conserve electricity.

- Brief your teams every morning

Your team should be informed about your new products and services.

A daily morning meeting before the show opens is a way to re-specify goals and answer questions that were asked the night before.

- Create buzz around your booth

To capture visitors' interest, create buzz around your booth with training sessions, wine & cheese samplings and other attention-drawing events.

After the trade show

- Follow-up is the key to success

A successful trade show is not just about meeting with customers and leads: Ensure that each lead has been treated and a follow-up goal is established. Thank your customers after the trade show and follow up on each request individually. Ensure that each lead has been processed with an objective follow-up. You will then be able to gauge the show's success and decide whether or not you will attend it again in the future.

- Reuse graphics after the trade show

Exhibition systems like Panoramic allow you to use portions of your graphics, which can be cut or re-sewn.

The single-sided frame can be mounted on a wall, and the double-sided frame lets you create fabric backwalls, which are like mini-exhibition kits.





BERLIN 

BERLINdisplays.com | info@berlindisplays.com

514.939.3600